

160100 頭蓋・頭蓋内損傷

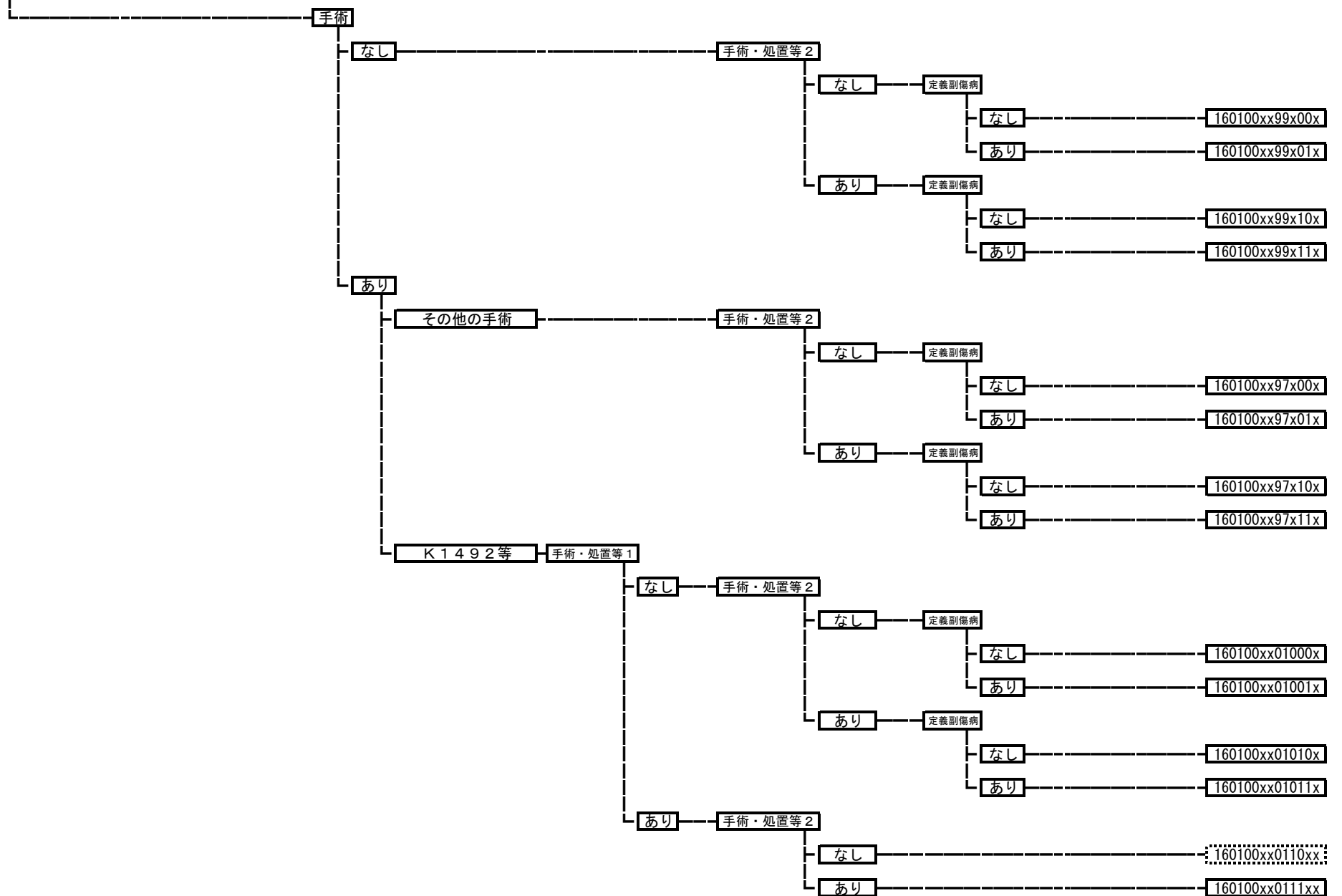

160200 顔面損傷（口腔、咽頭損傷を含む。）

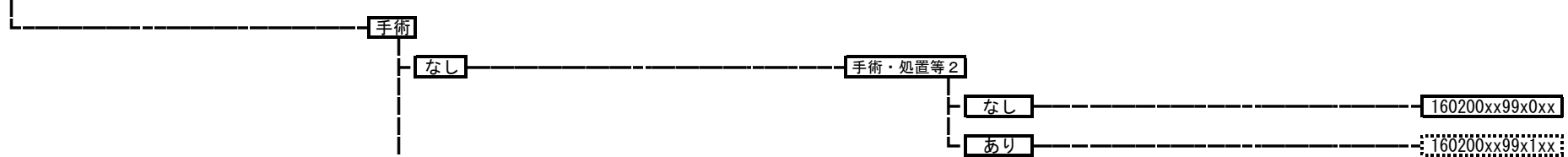

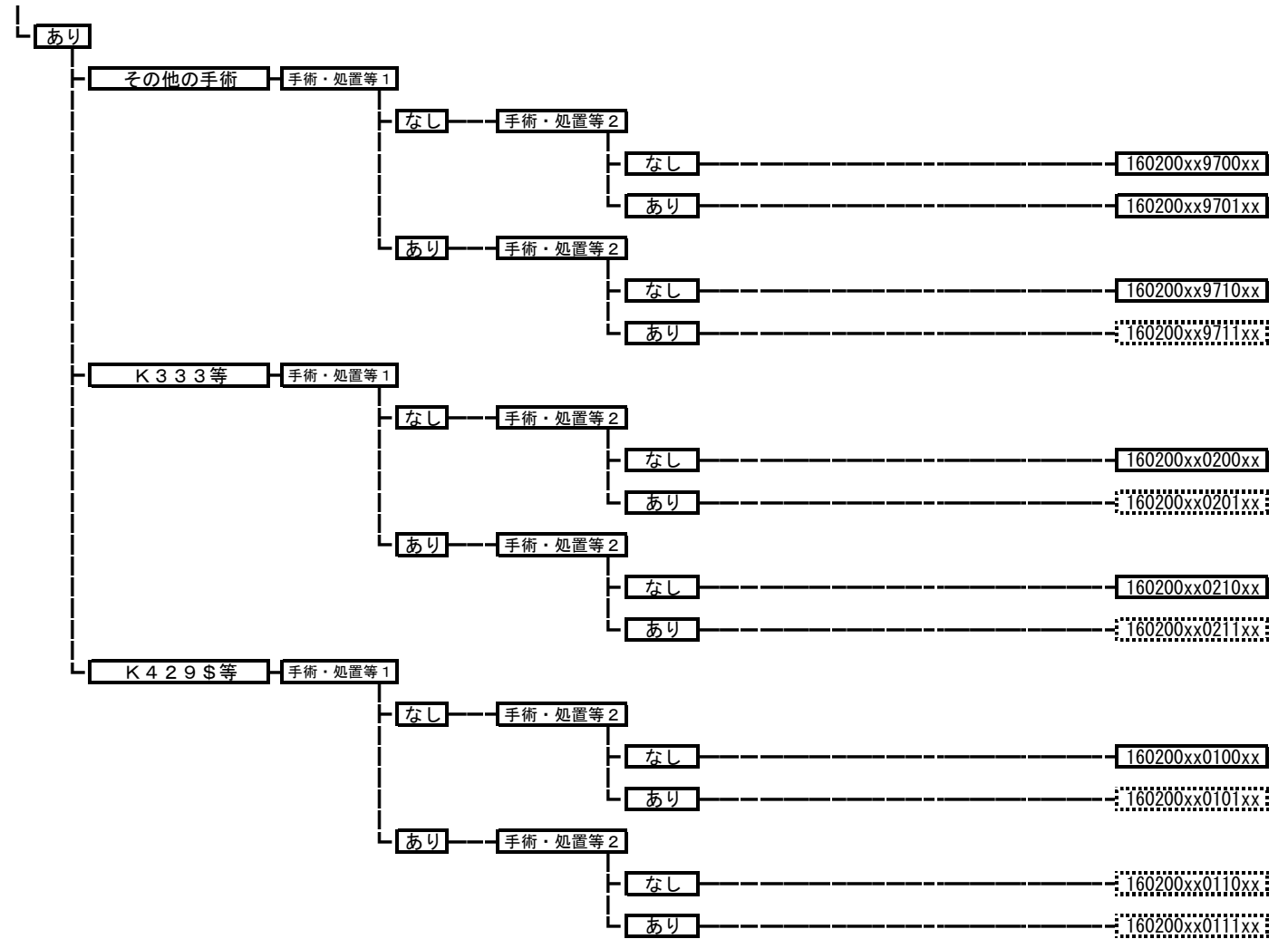

160250 眼損傷

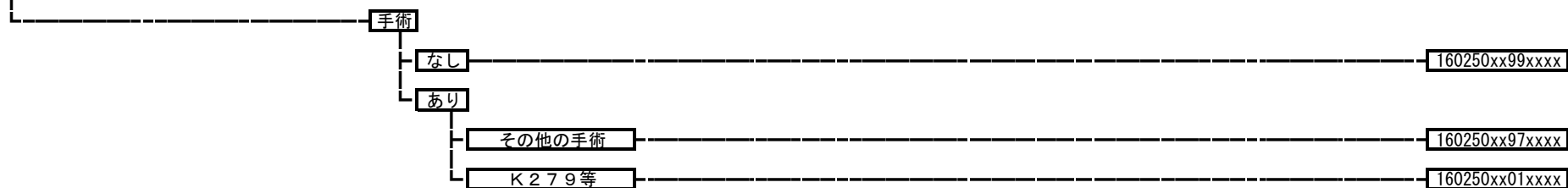

160300 喉頭・頸部気管損傷

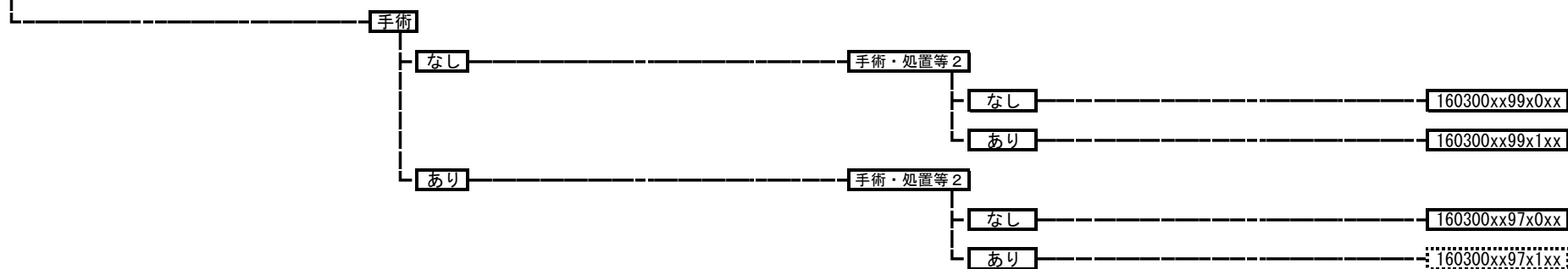

160350 頸部損傷（喉頭・頸部気管損傷、頸椎頸髄損傷を除く。）

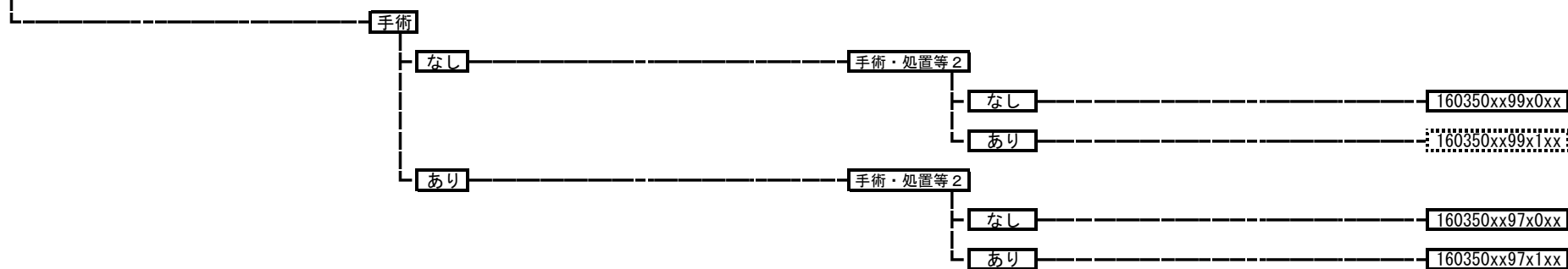

160400 胸郭・横隔膜損傷

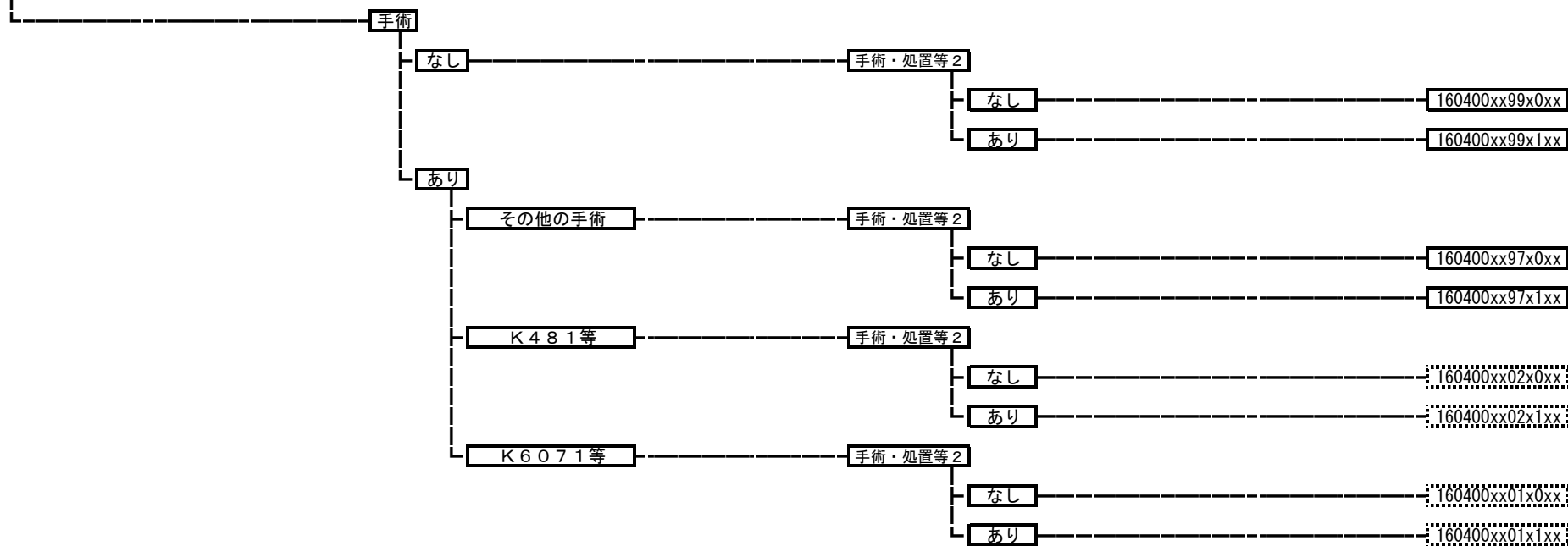

160440 外耳・中耳損傷（異物を含む。）

160440xxxxxxxx

160450 肺・胸部気管・気管支損傷

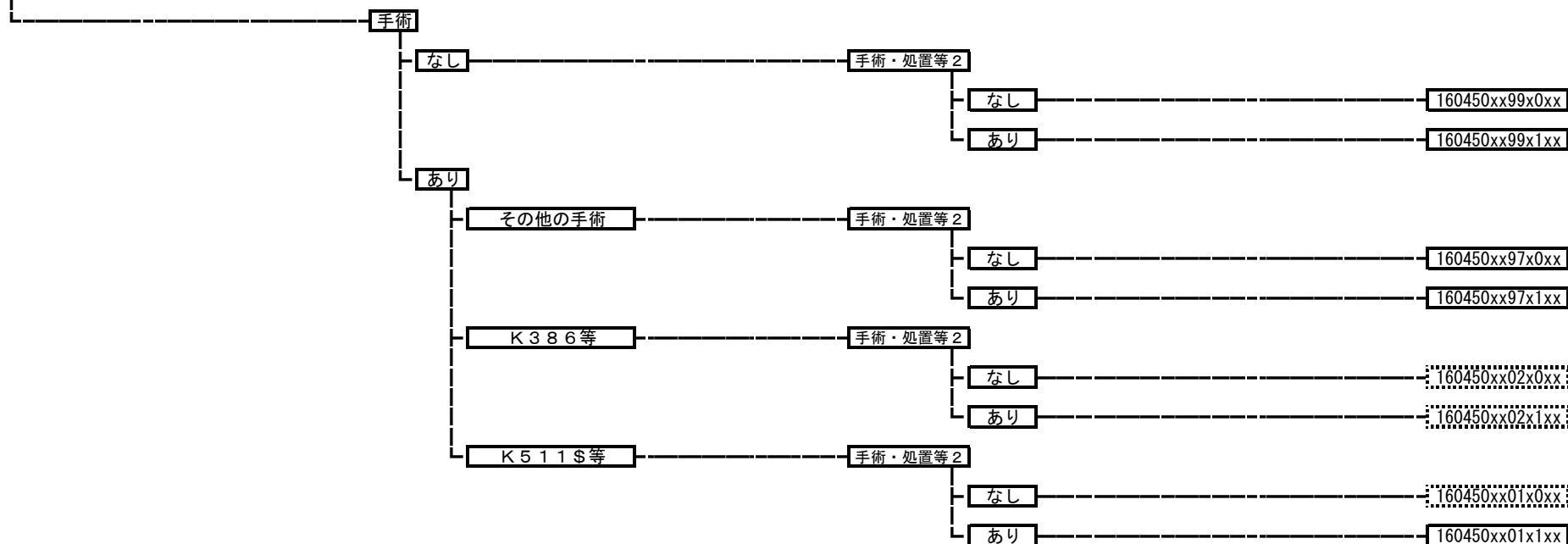

160480 心・大血管損傷

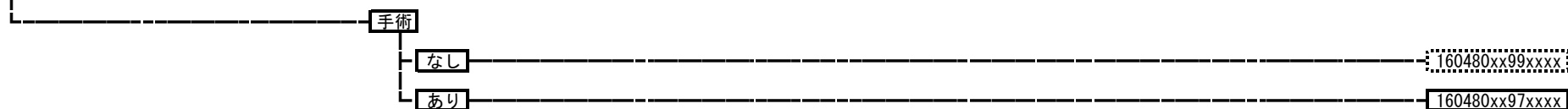

160500 食道・胃損傷

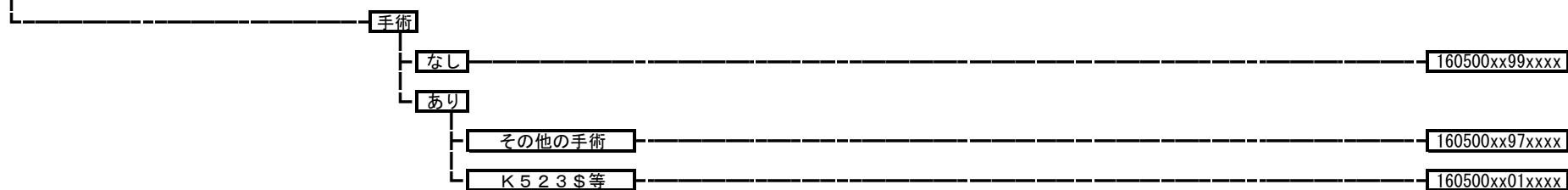

160510 肝・胆道・膵・脾損傷

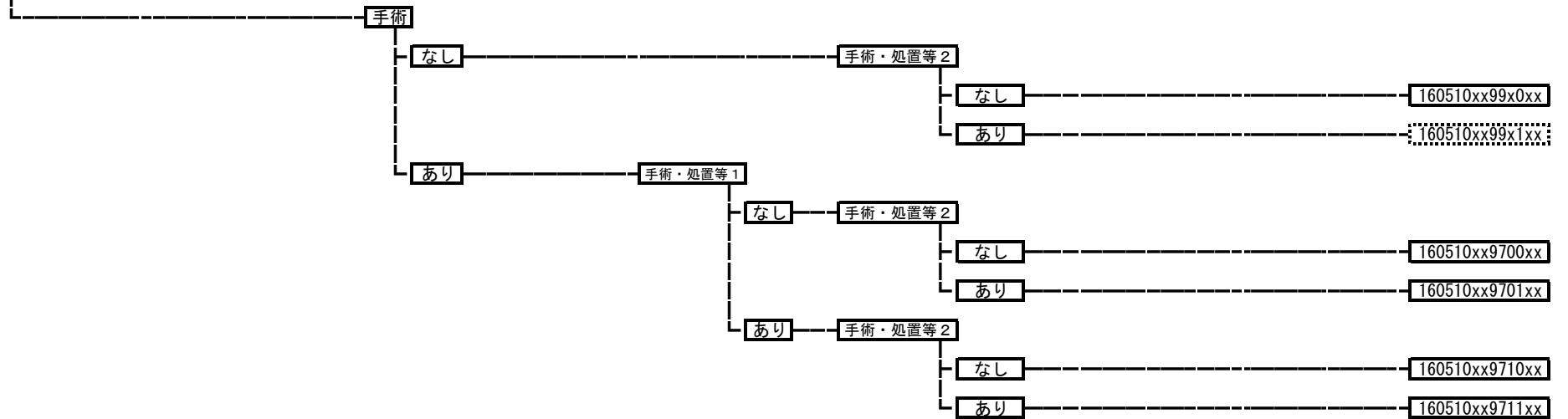

16054x 腸管損傷（胃以外）

- 160541 小腸・小腸腸間膜損傷
- 160542 結腸・直腸腸間膜損傷
- 160543 直腸・肛門損傷

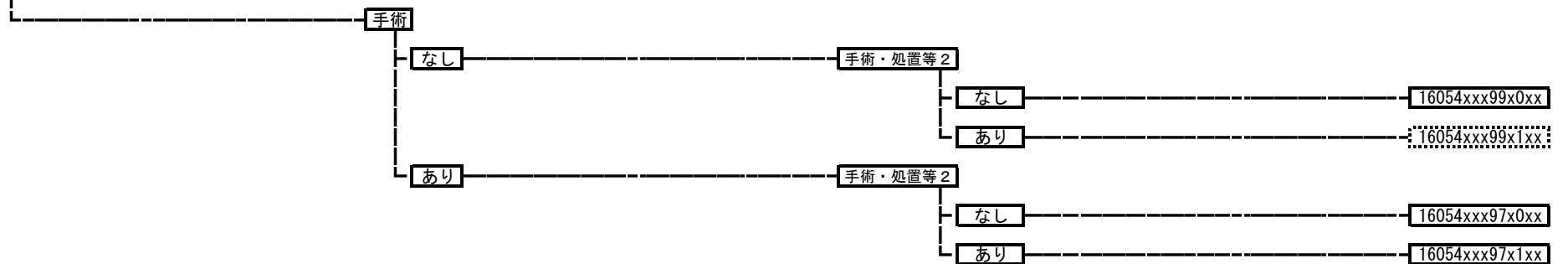

160570 腹部血管損傷

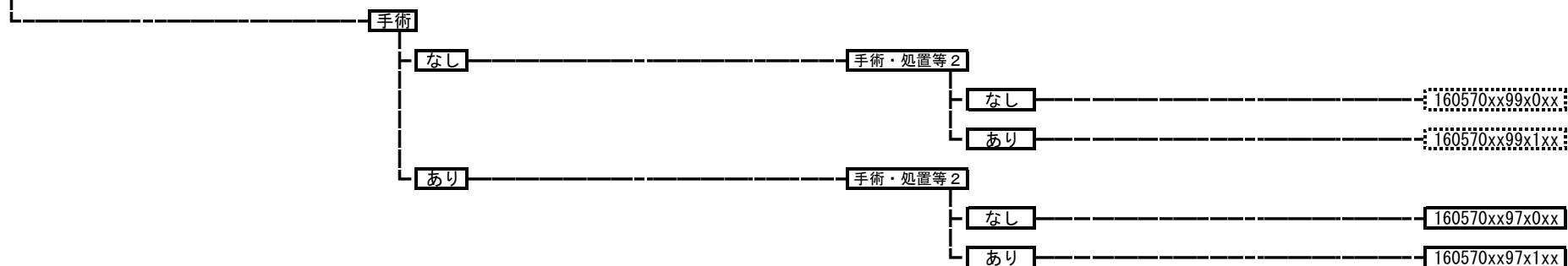

160575 その他腹腔内臓器の損傷

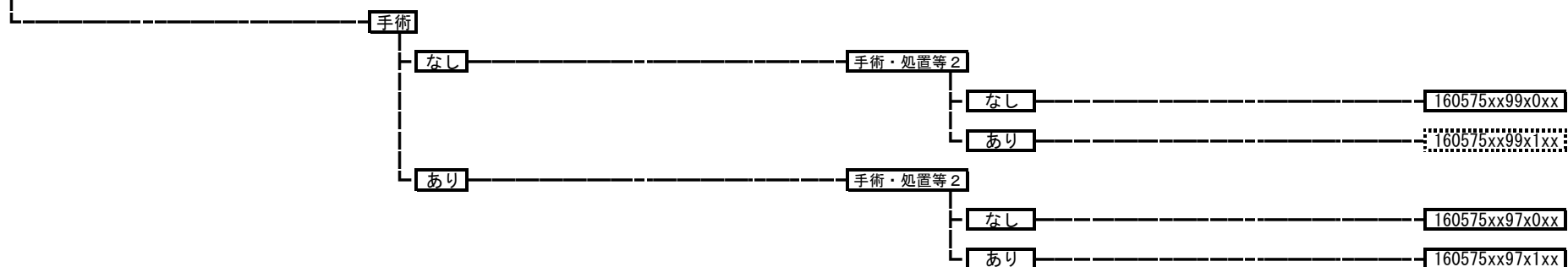

160580 腹壁損傷

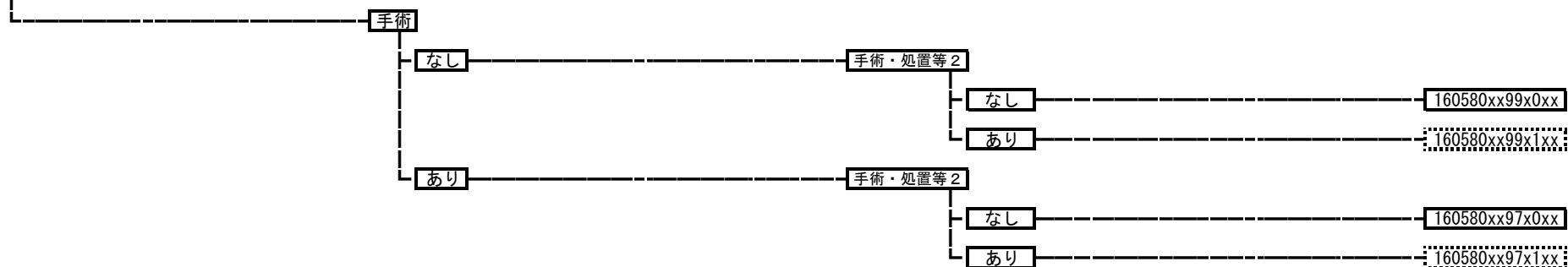

160590 四肢神経損傷
160590xxxxxxxx

160600 四肢血管損傷
160600xxxxxxxx

160610 四肢筋腱損傷

- 手術
 - なし 160610xx99xxxx
 - あり
 - その他の手術 160610xx97xxxx
 - K037等 160610xx02xxxx
 - K079\$等 160610xx01xxxx

160620 肘、膝の外傷（スポーツ障害等を含む。）

- 手術
 - なし 160620xx99xxxx
 - あり
 - その他の手術 160620xx97xxxx
 - K065\$等 160620xx02xxxx
 - K037等 160620xx01xxxx

160640 外傷性切断

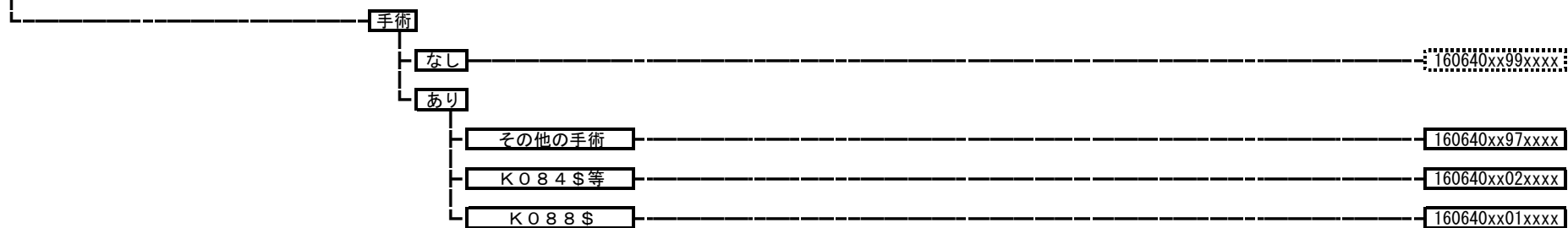

160650 コンパートメント症候群

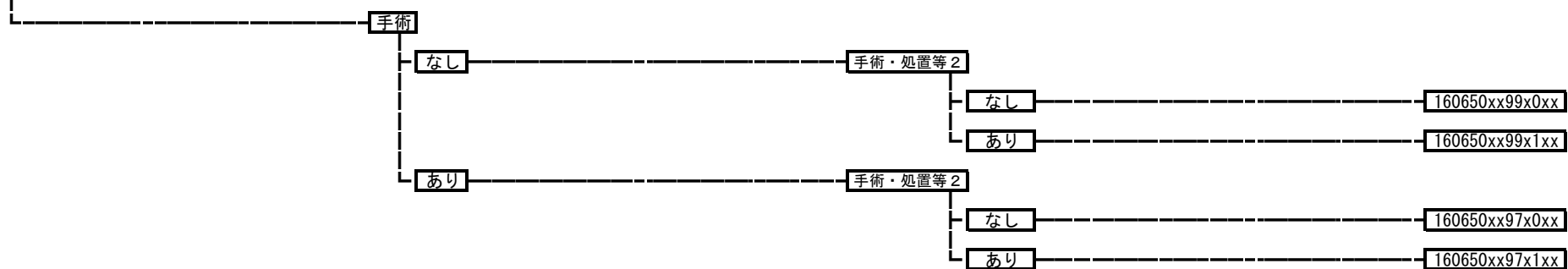

160660 皮下軟部損傷・挫滅損傷、開放創

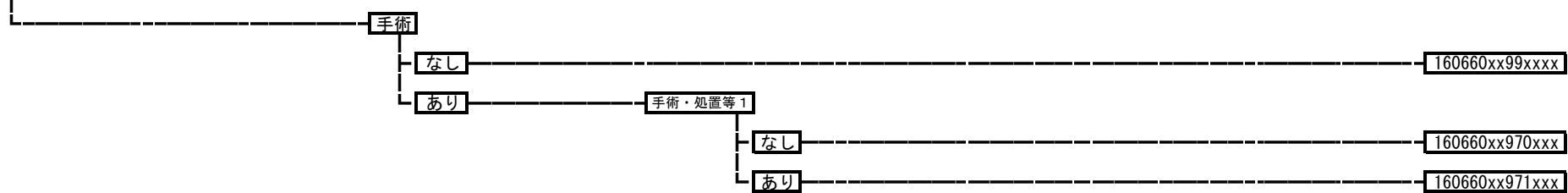

160690 胸椎、腰椎以下骨折損傷（胸・腰髄損傷を含む。）

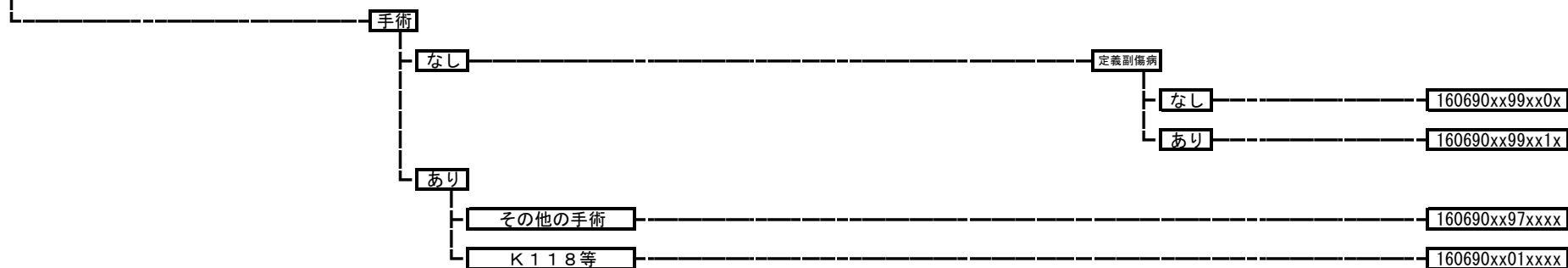

160700 鎖骨骨折、肩甲骨骨折

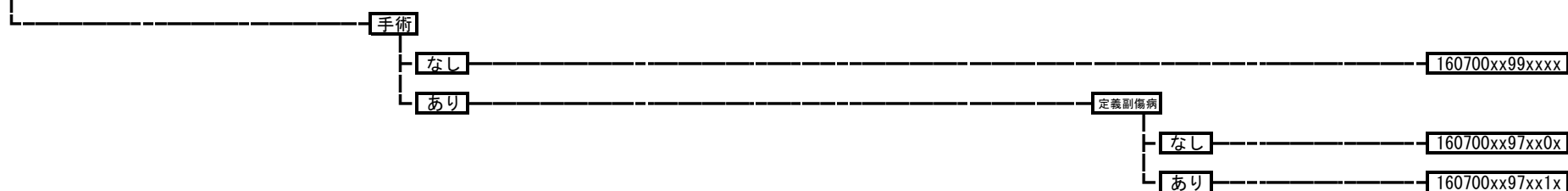

160710 鎖骨骨折、肩甲骨骨折の開放骨折

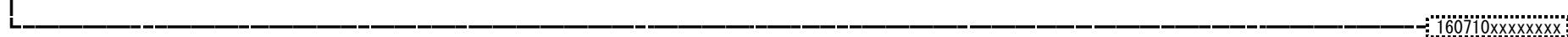

160720 肩関節周辺の骨折脱臼

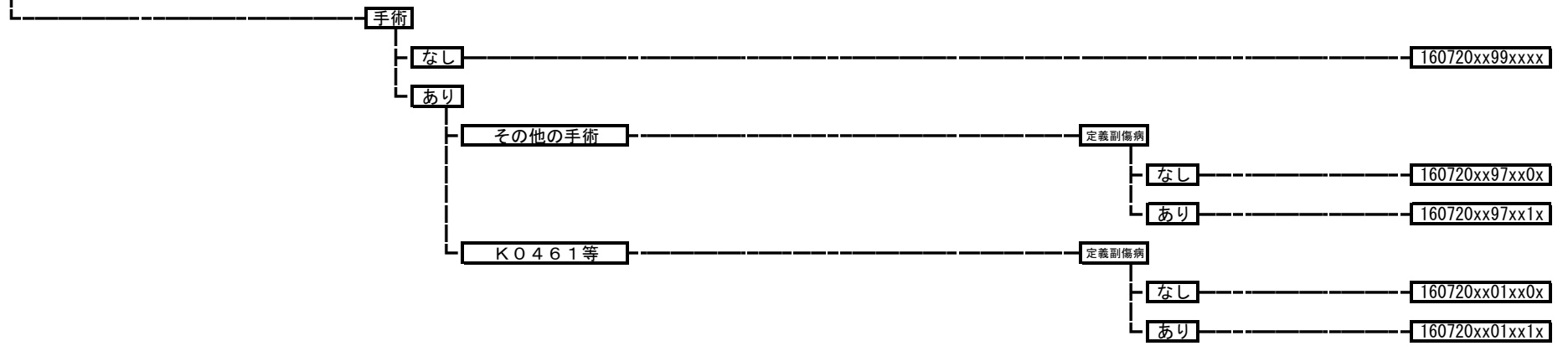

160730 肩関節周辺開放骨折



160740 肘関節周辺の骨折・脱臼

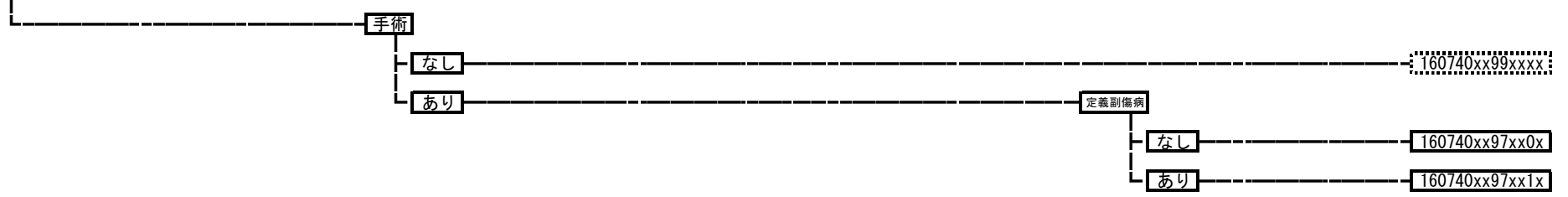

160750 肘関節周辺開放骨折



160760 前腕の骨折

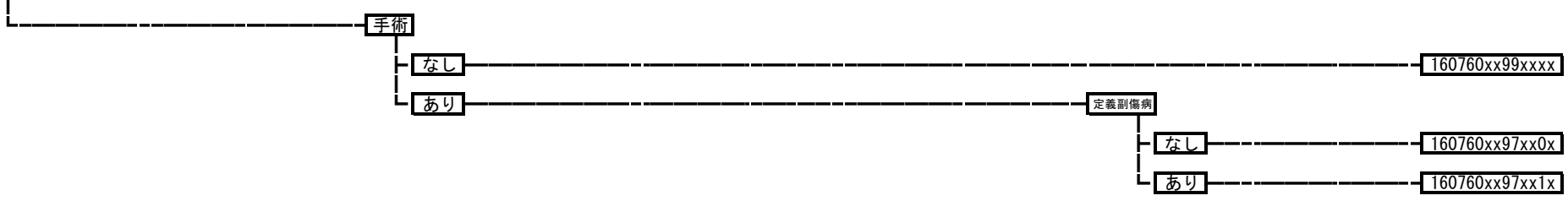

160770 前腕開放骨折

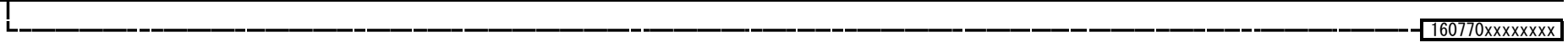

160780 手関節周辺骨折脱臼

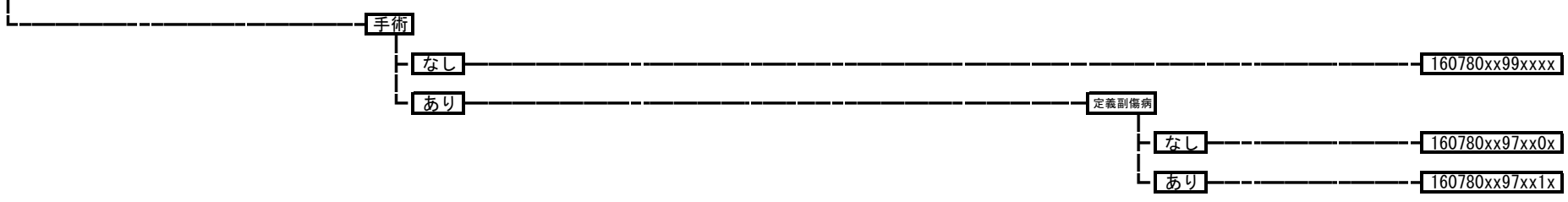

160790 手関節周辺開放骨折



160800 股関節大腿近位骨折

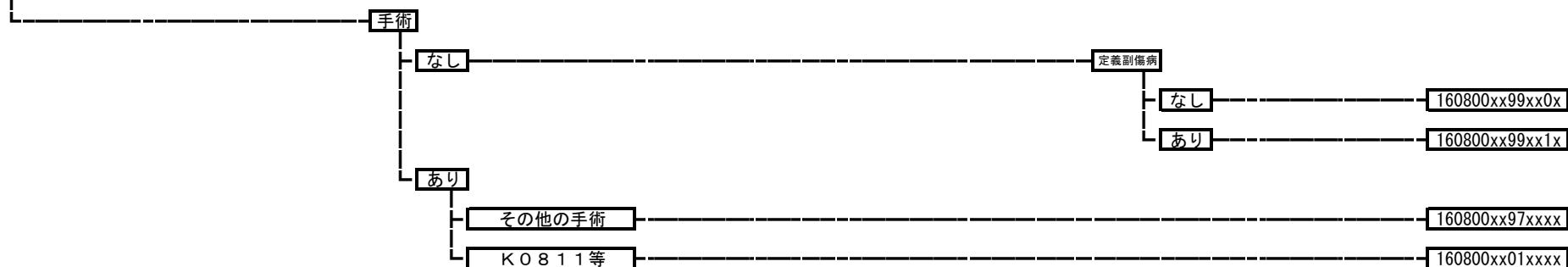

160810 股関節大腿近位開放骨折



160820 膝関節周辺骨折・脱臼

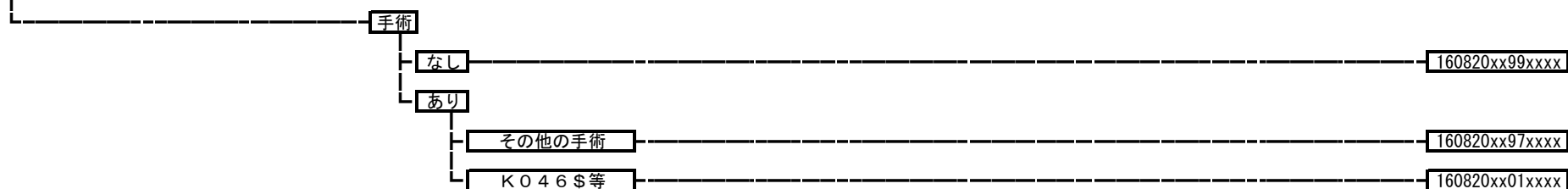

160830 膝関節周辺開放骨折

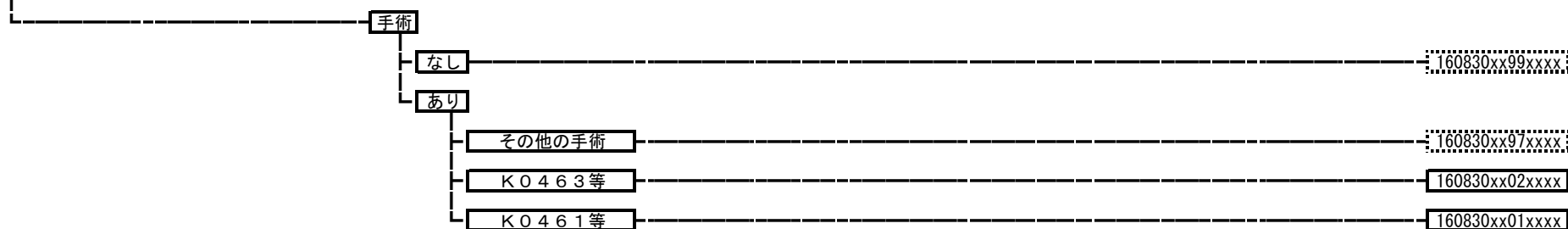

160835 下腿足関節周辺骨折

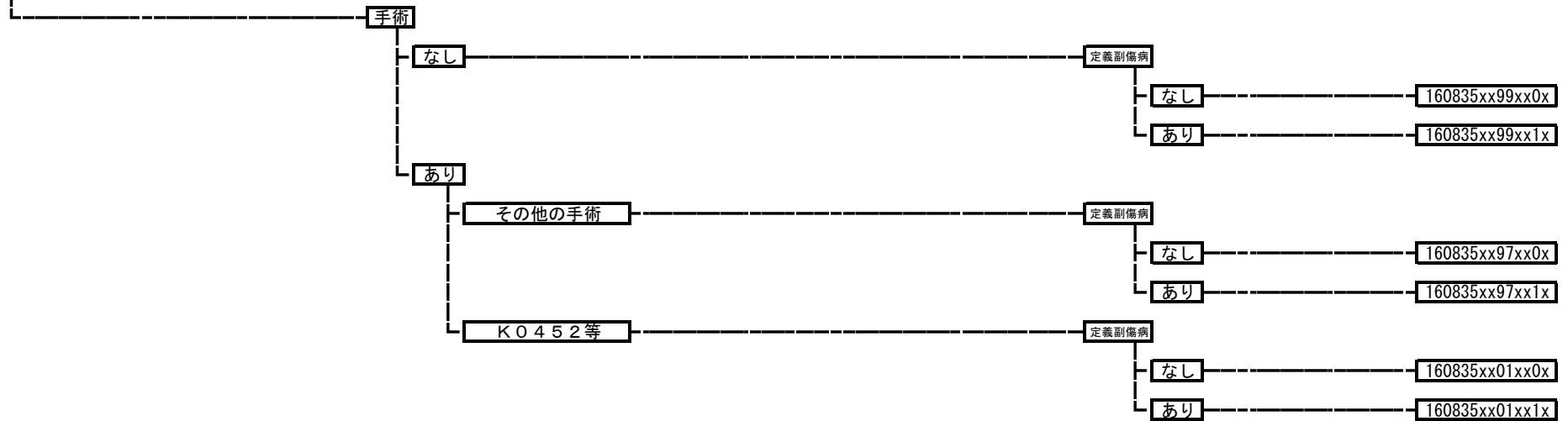

160840 下腿足関節周辺開放骨折

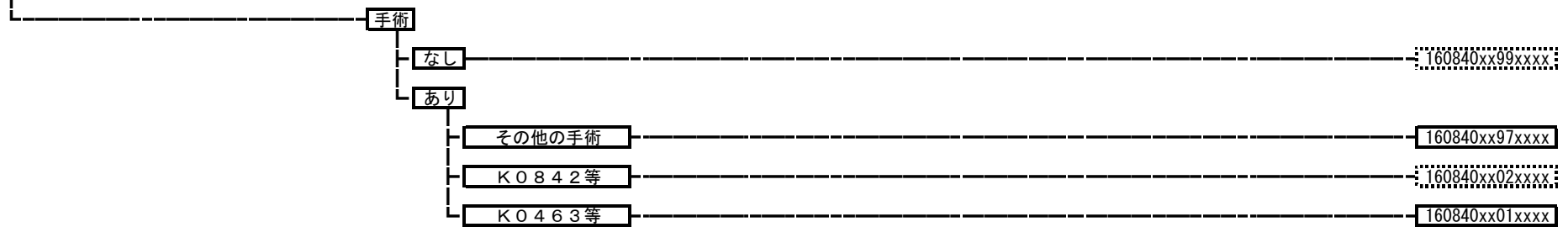

160850 足関節・足部の骨折、脱臼

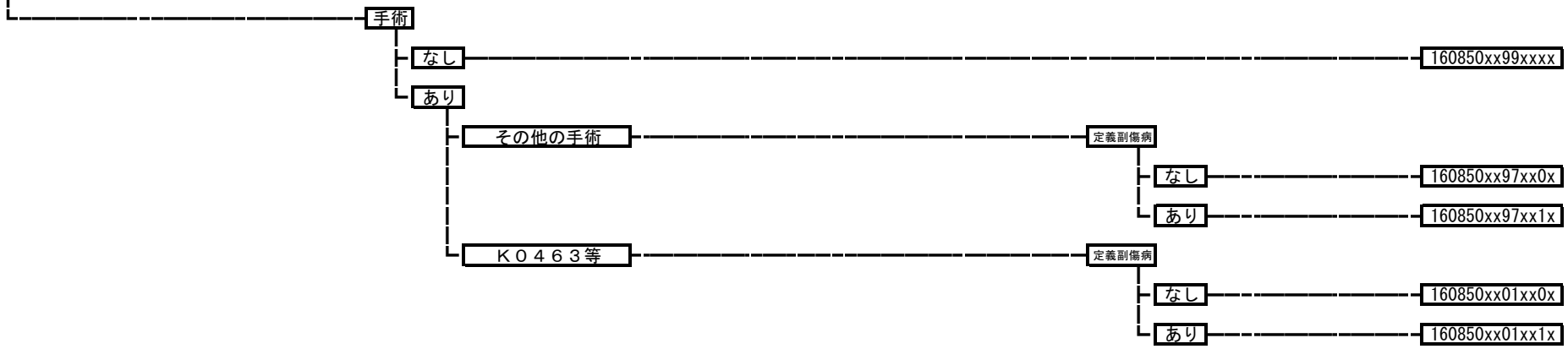

160860 足関節・足部の骨折、脱臼、開放骨折

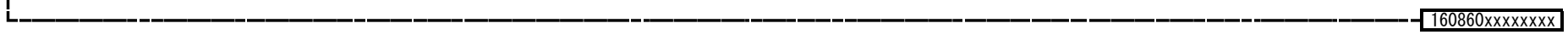

160870 頸椎頸髄損傷

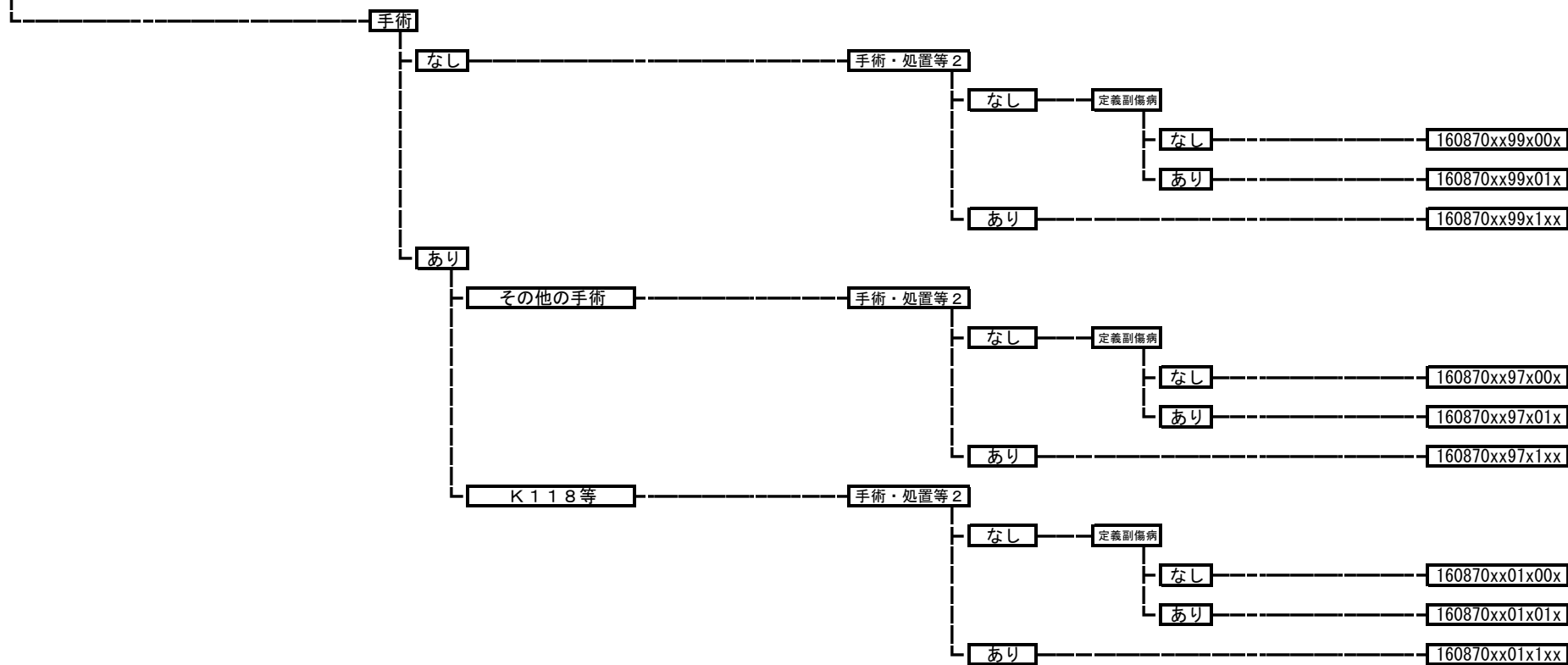

160950 腎・尿管損傷



160960 膀胱・尿道損傷

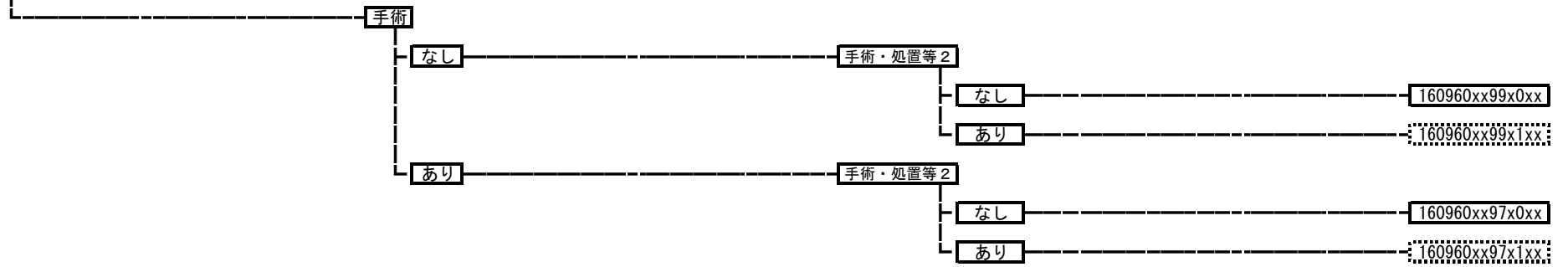

160970 生殖器損傷

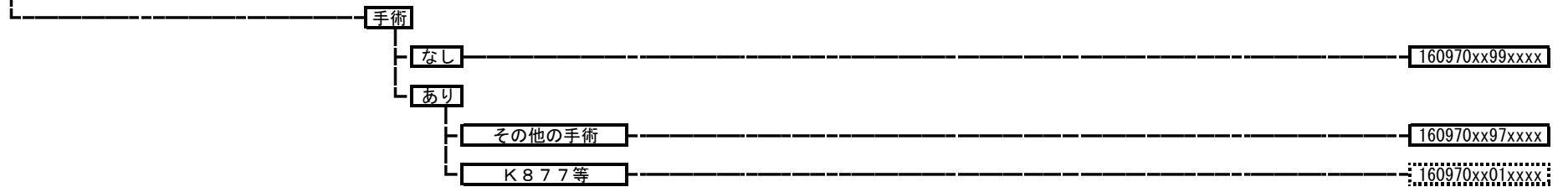

160980 骨盤損傷

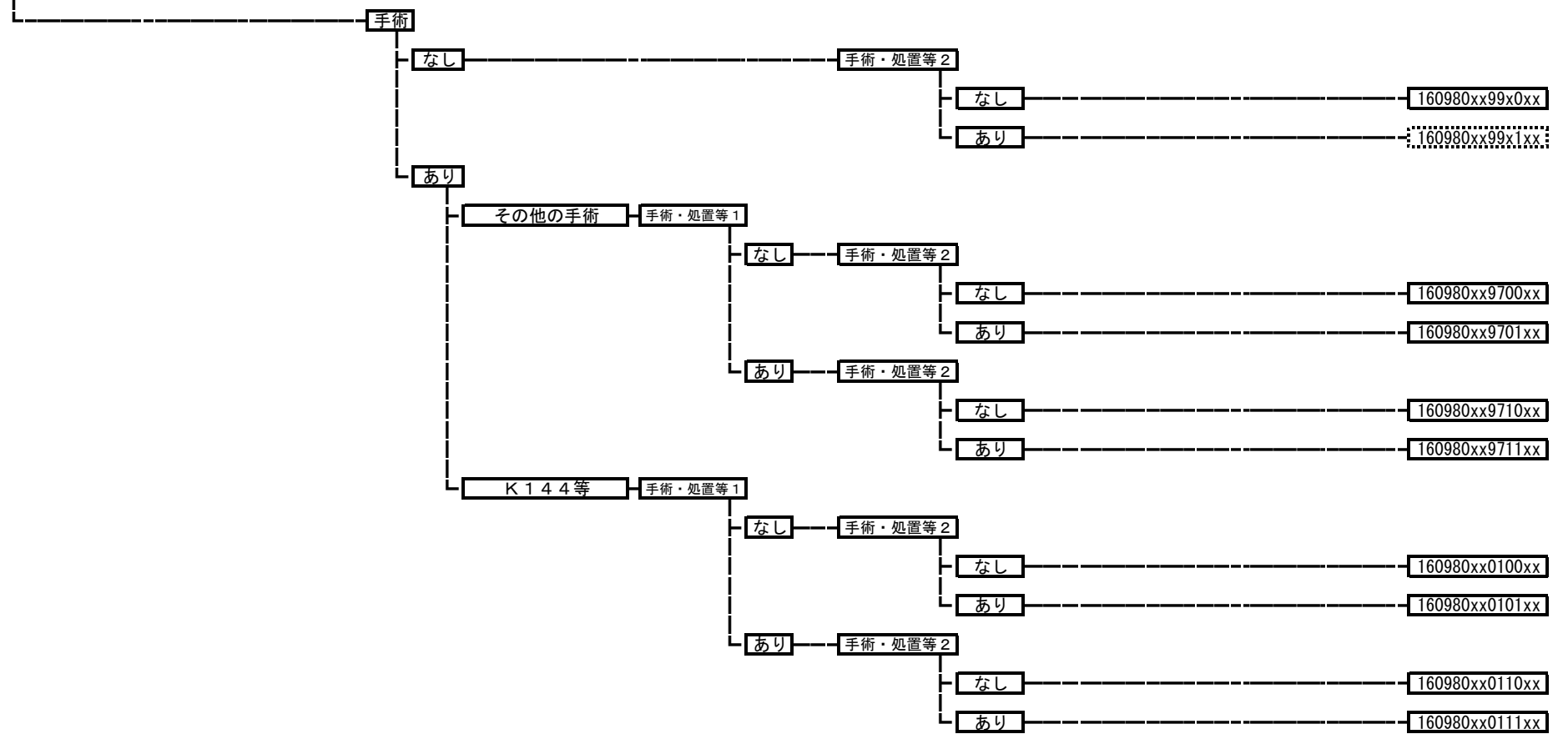

160990 多部位外傷

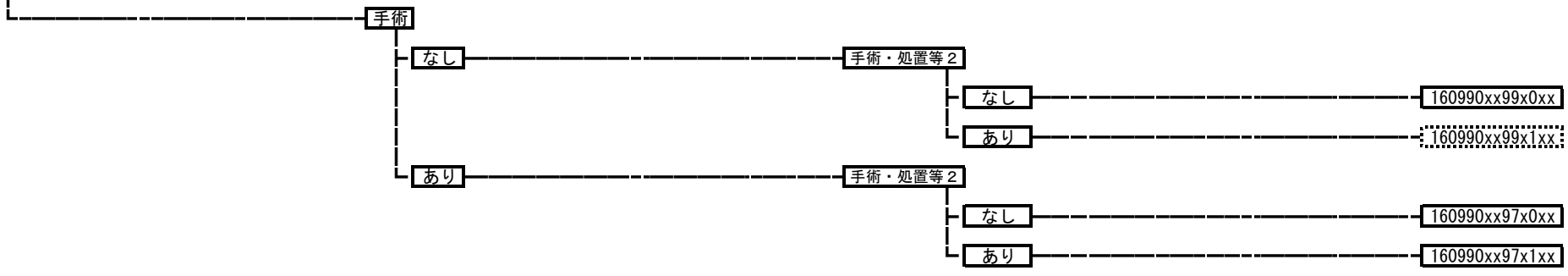

160995 気道熱傷

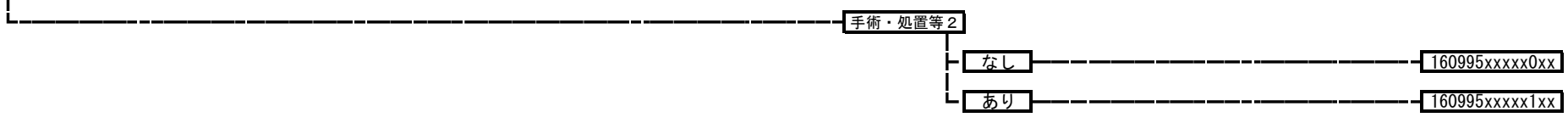

161000 熱傷・化学熱傷・凍傷・電撃傷

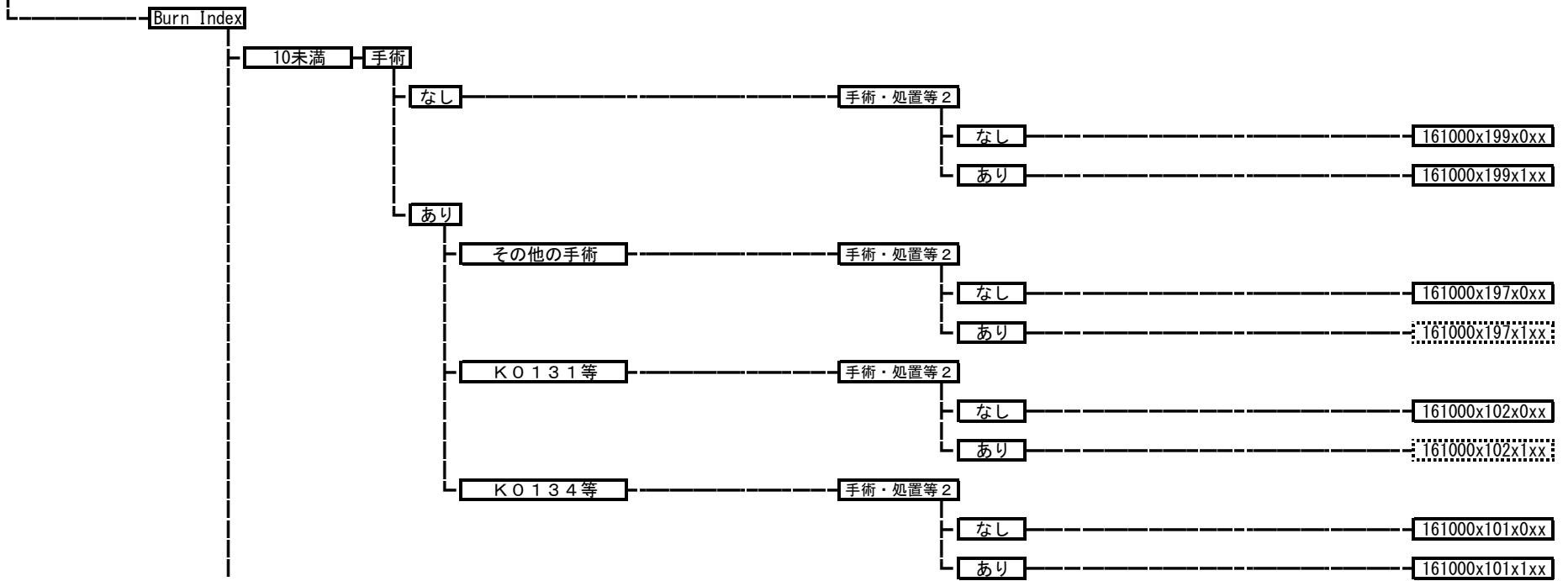

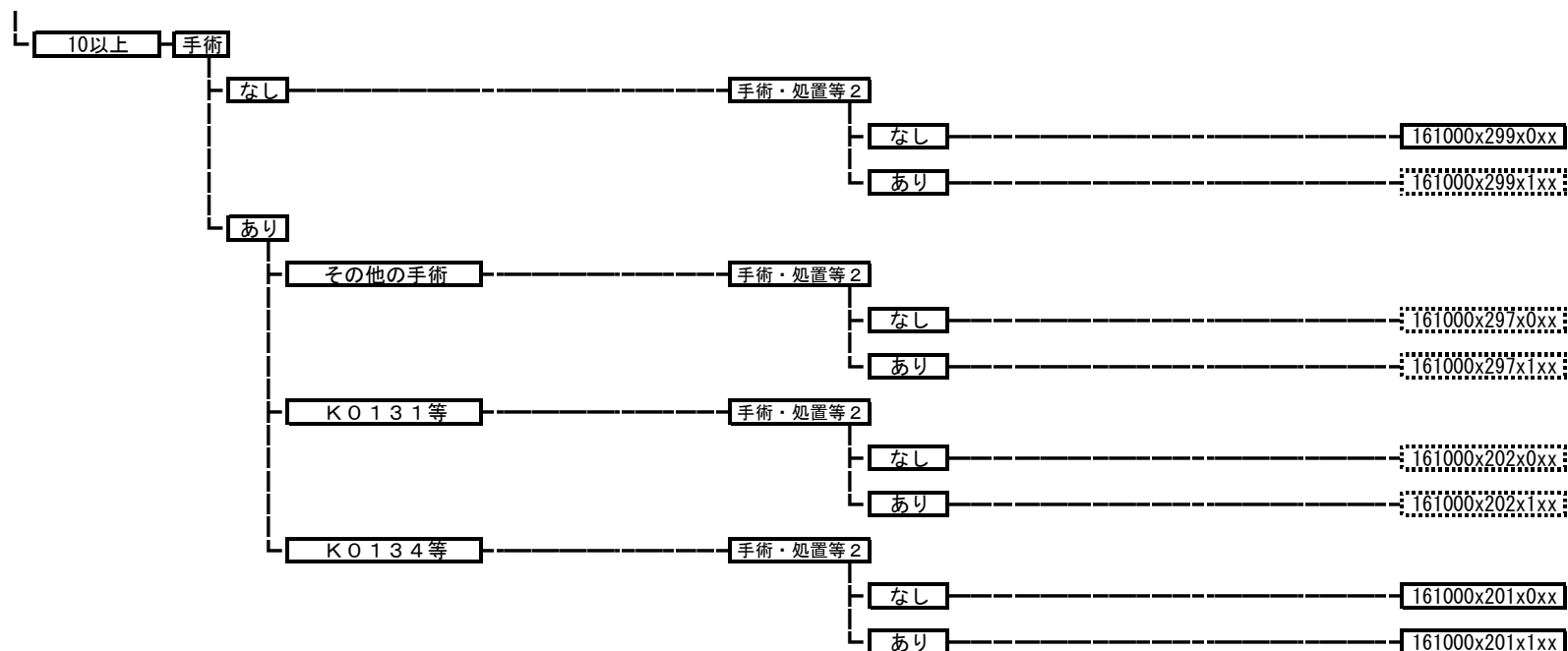

161020 体温異常

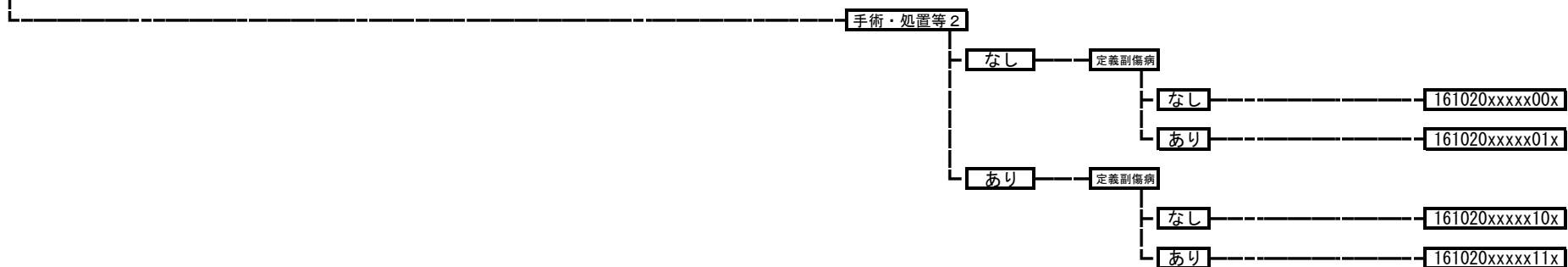

161030 気圧による損傷

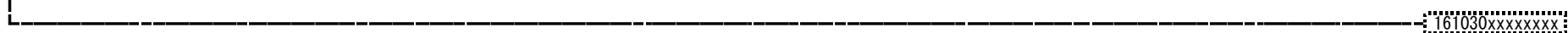

161040 損傷の続発性、後遺症 161040xxxxxxxx

161060 詳細不明の損傷等

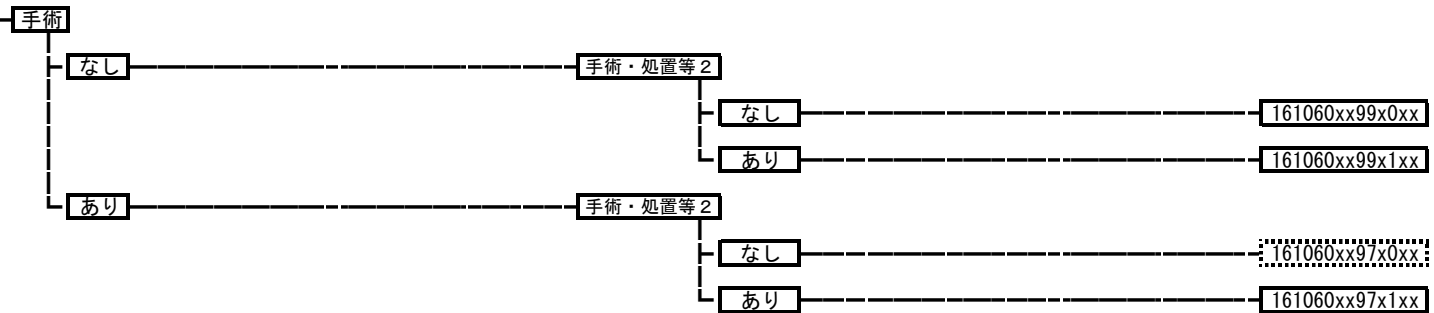

161070 薬物中毒（その他の中毒）

手術・処置等 2
 1：人工呼吸、中心静脈注射
 2：人工腎臓 その他の場合
 3：血漿交換療法、吸着式血液浄化法

