

150010 ウイルス性腸炎

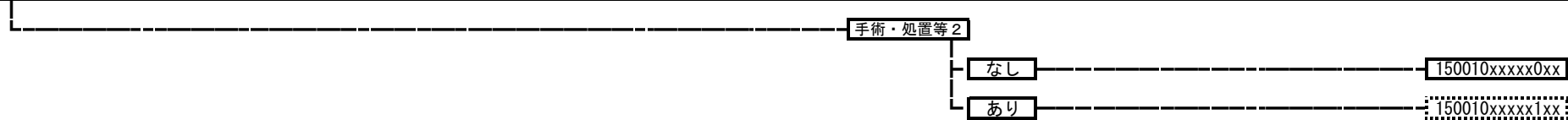

150020 細菌性腸炎

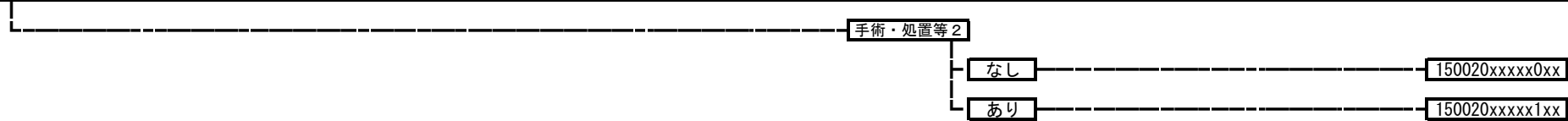

150021 偽膜性腸炎

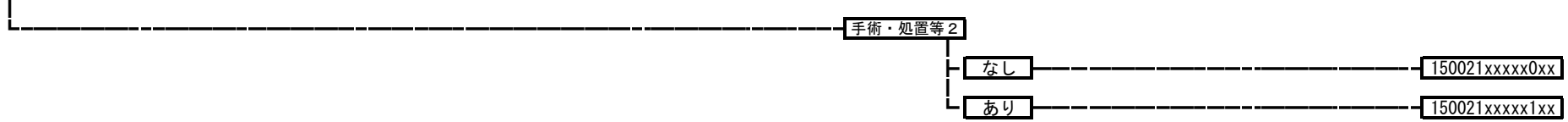

150030 ウイルス性髄膜炎

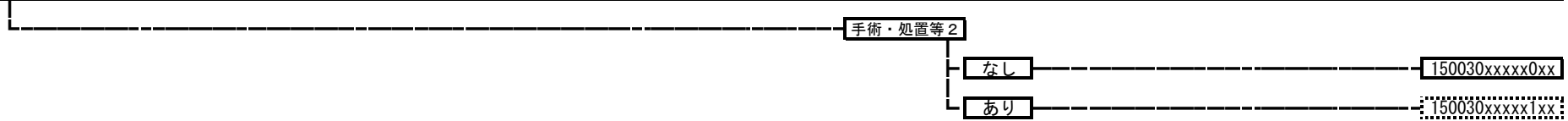

150040 熱性けいれん

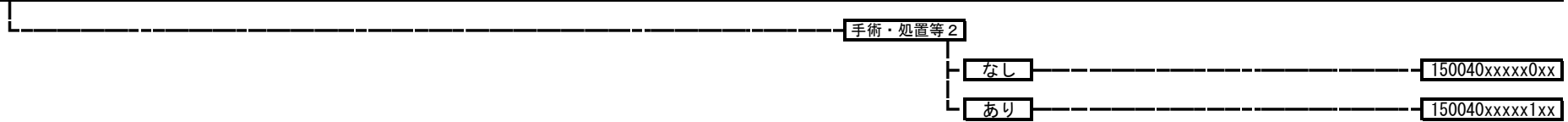

150050 急性脳炎急性脳症

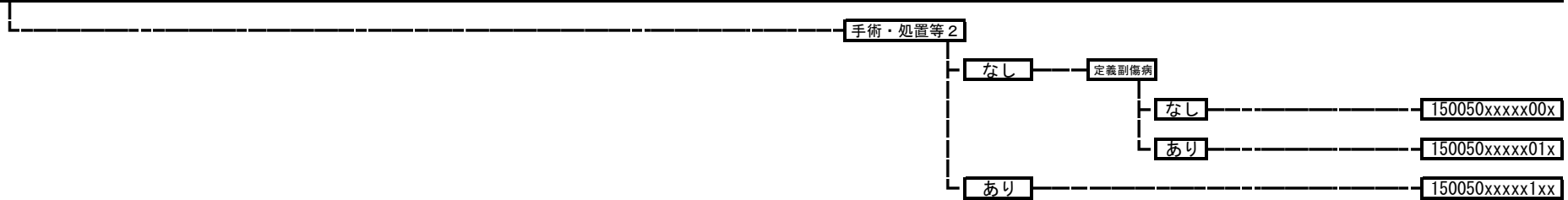

150070 川崎病

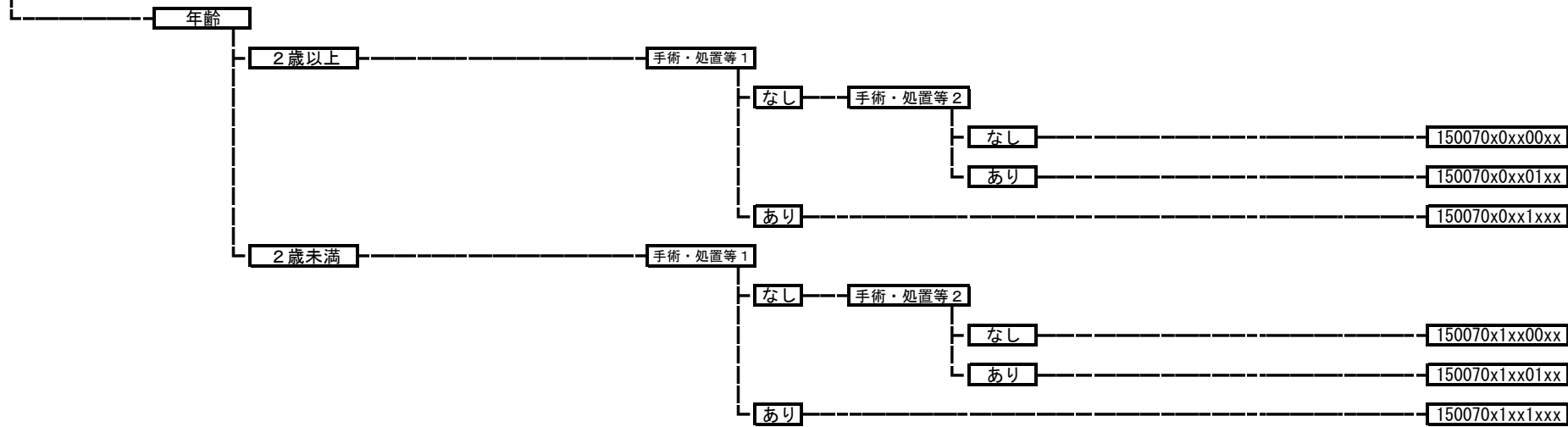

150100 虐待症候群

150100xxxxxxxxx

150110 染色体異常（ターナー症候群及びクラインフェルター症候群を除く。）

150110xxxxxxxxx