

| | |
|--------|---------------|
| 11001x | 腎腫瘍 |
| | 110011 腎の悪性腫瘍 |
| | 110012 腎の良性腫瘍 |

手術・処置等 2
 1: 人工呼吸など
 2: ソラフェニブトシル酸など
 3: テムシロリムス
 4: IL-2

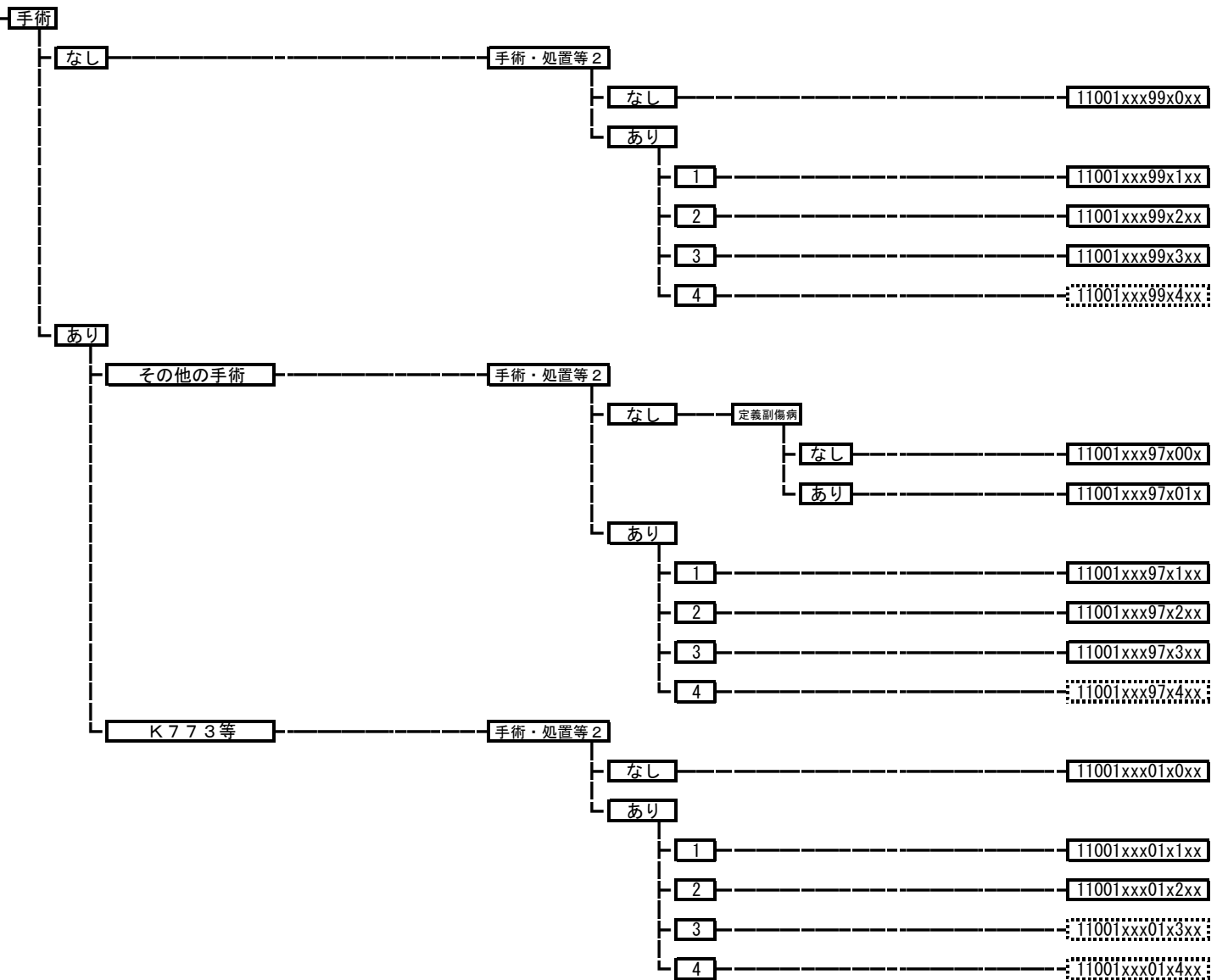

| | | |
|---------------|---------|---------|
| 11002x | 性器の悪性腫瘍 | |
| | 110021 | 陰茎の悪性腫瘍 |
| | 110022 | 性器の悪性腫瘍 |



| | | |
|---------------|------------|--------------|
| 11004x | 尿道・性器の良性腫瘍 | |
| | 110041 | 尿道腫瘍 |
| | 110042 | 性器の良性腫瘍（その他） |

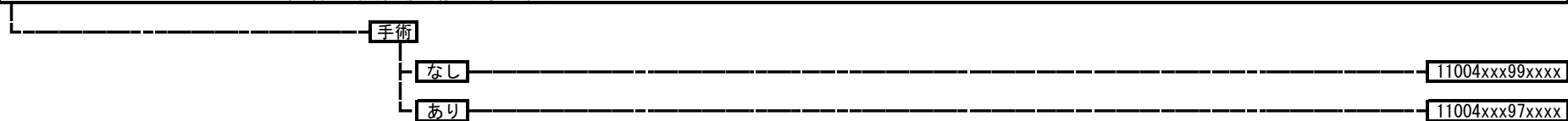

110050 後腹膜疾患

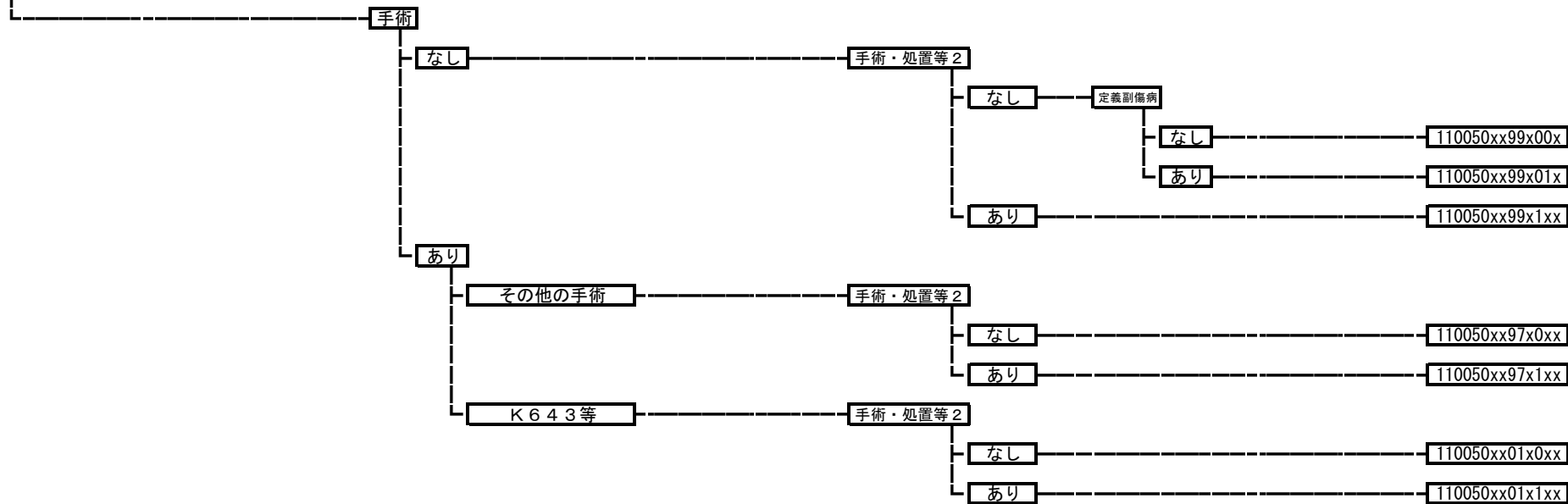

110060 腎盂・尿管の悪性腫瘍

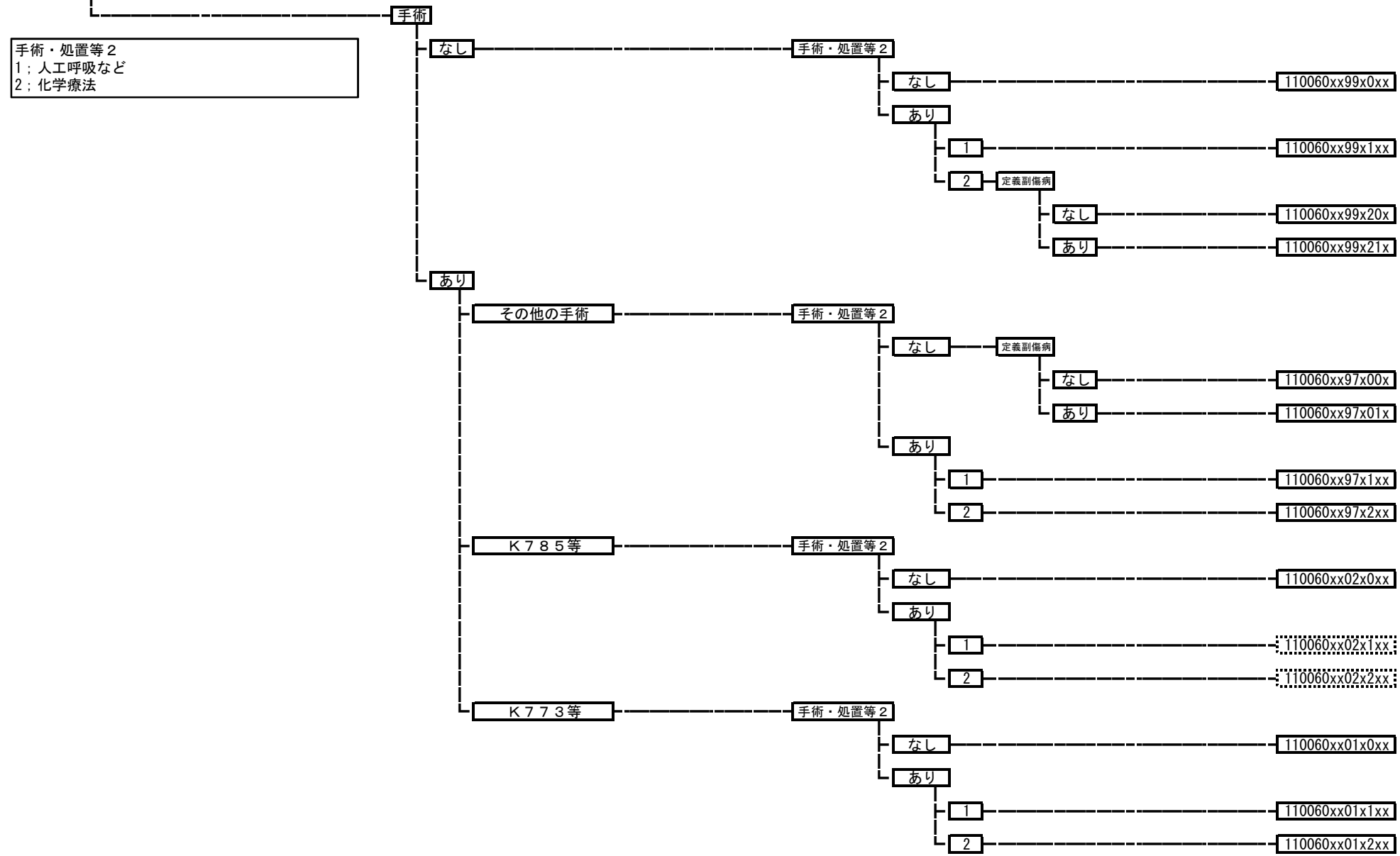

110070 膀胱腫瘍

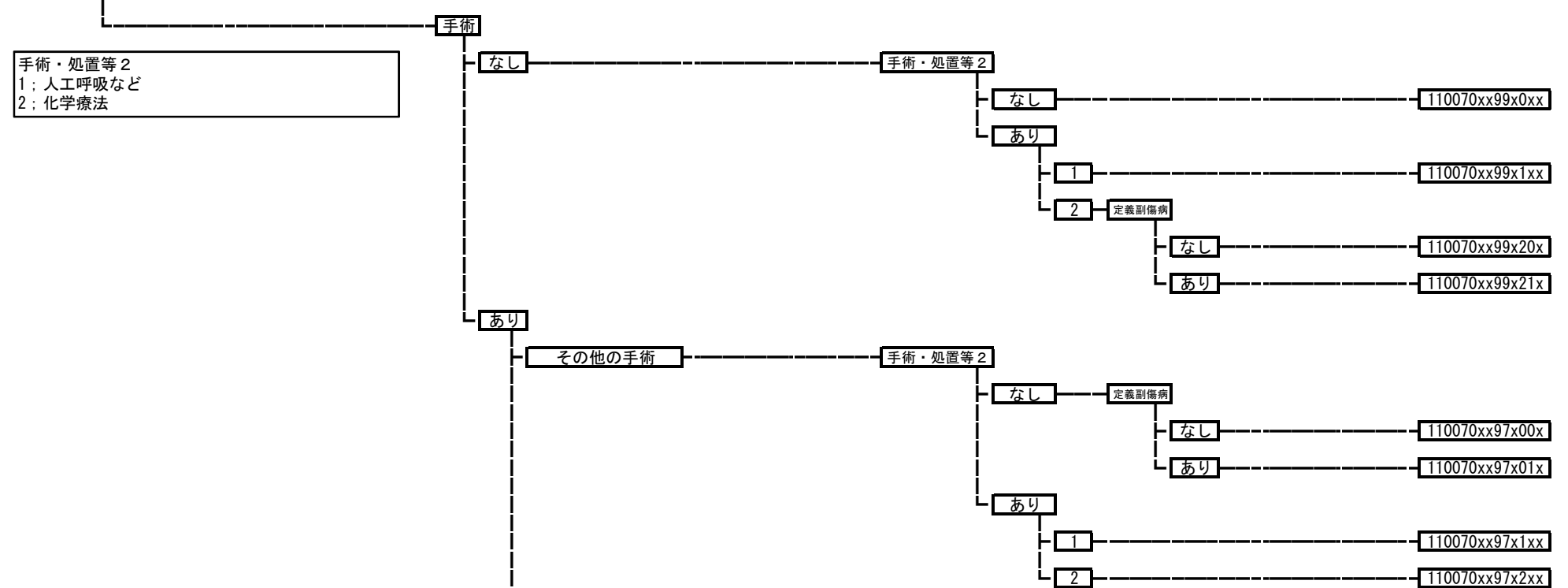

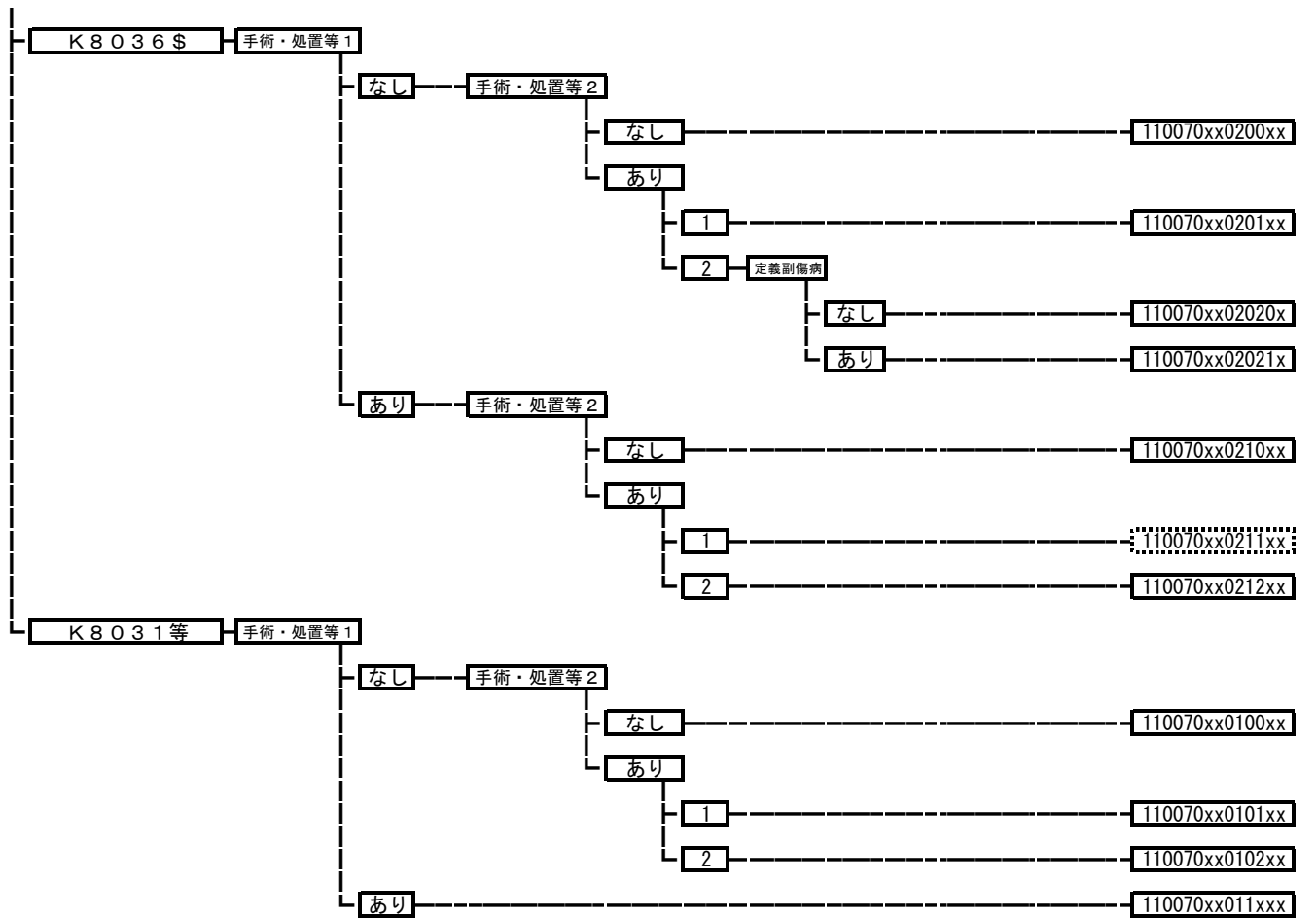

110080 前立腺の悪性腫瘍

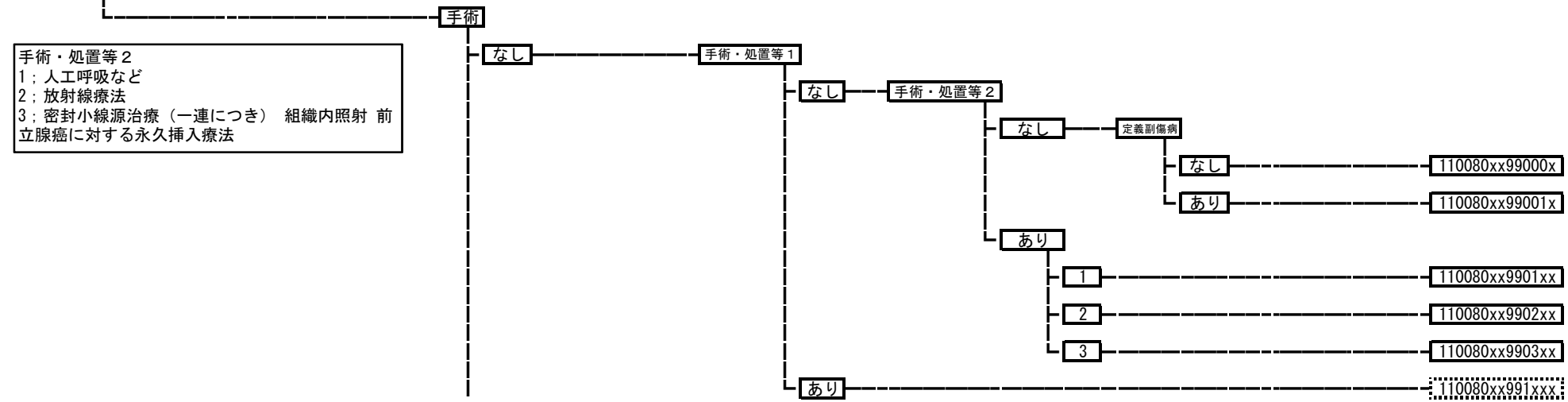

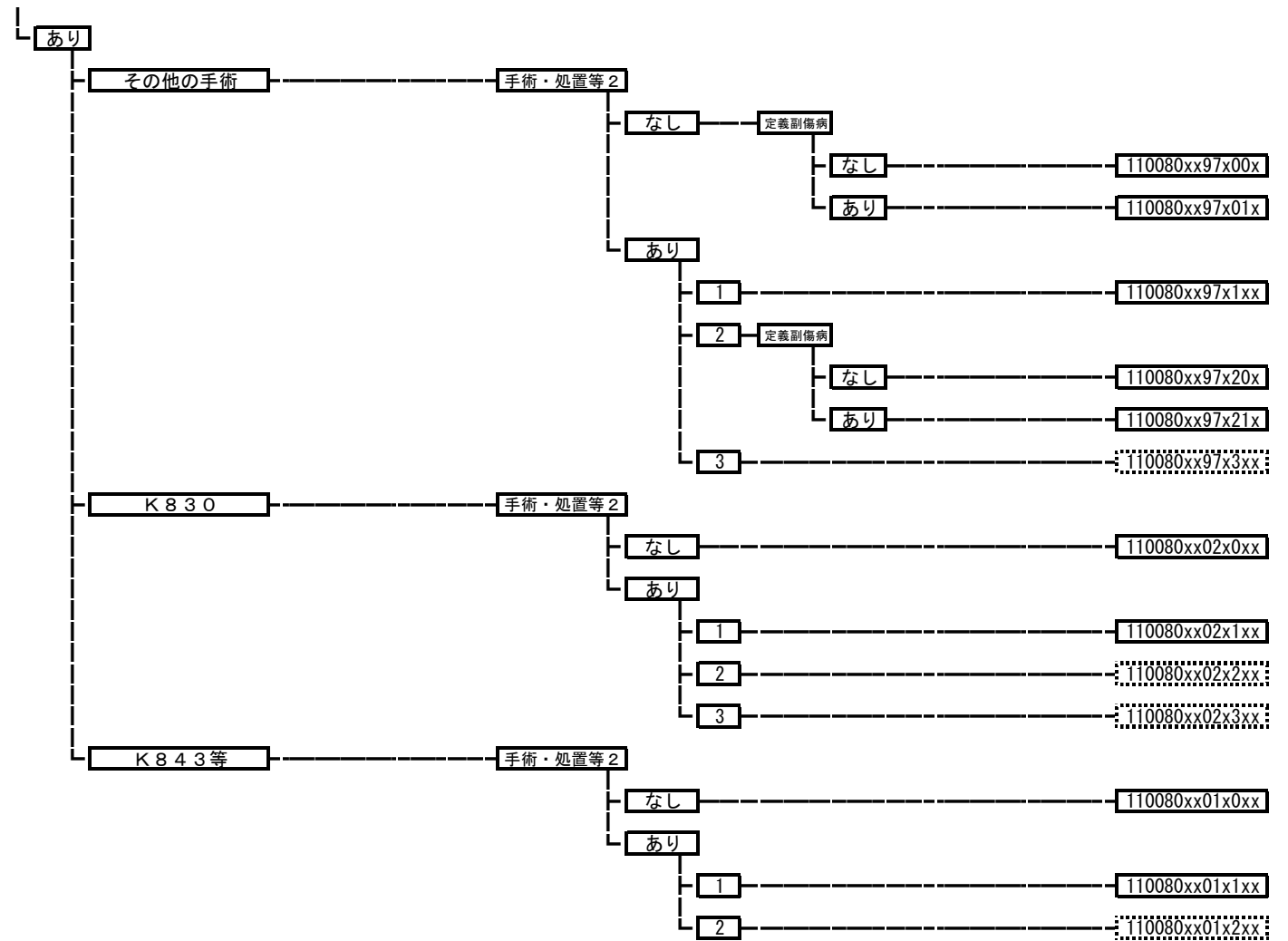

110100 精巣腫瘍

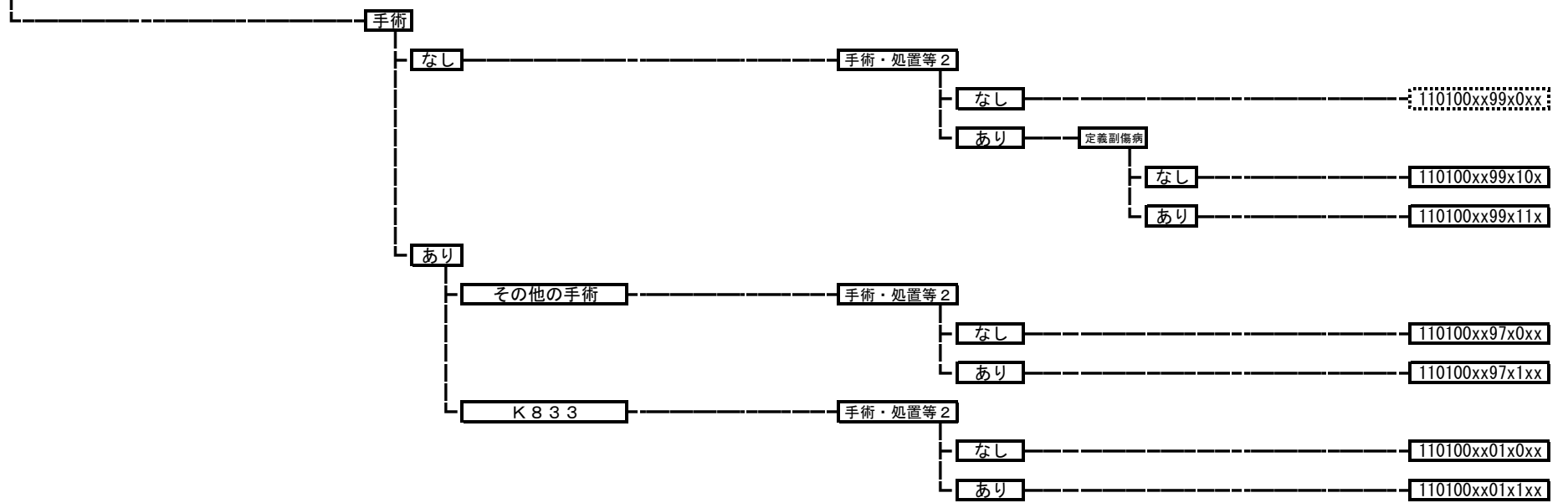

| | | |
|---------------|---------------|--------------|
| 11012x | 上部尿路疾患 | |
| | 110121 | 上部尿路結石 |
| | 110122 | 上部尿路疾患 (その他) |

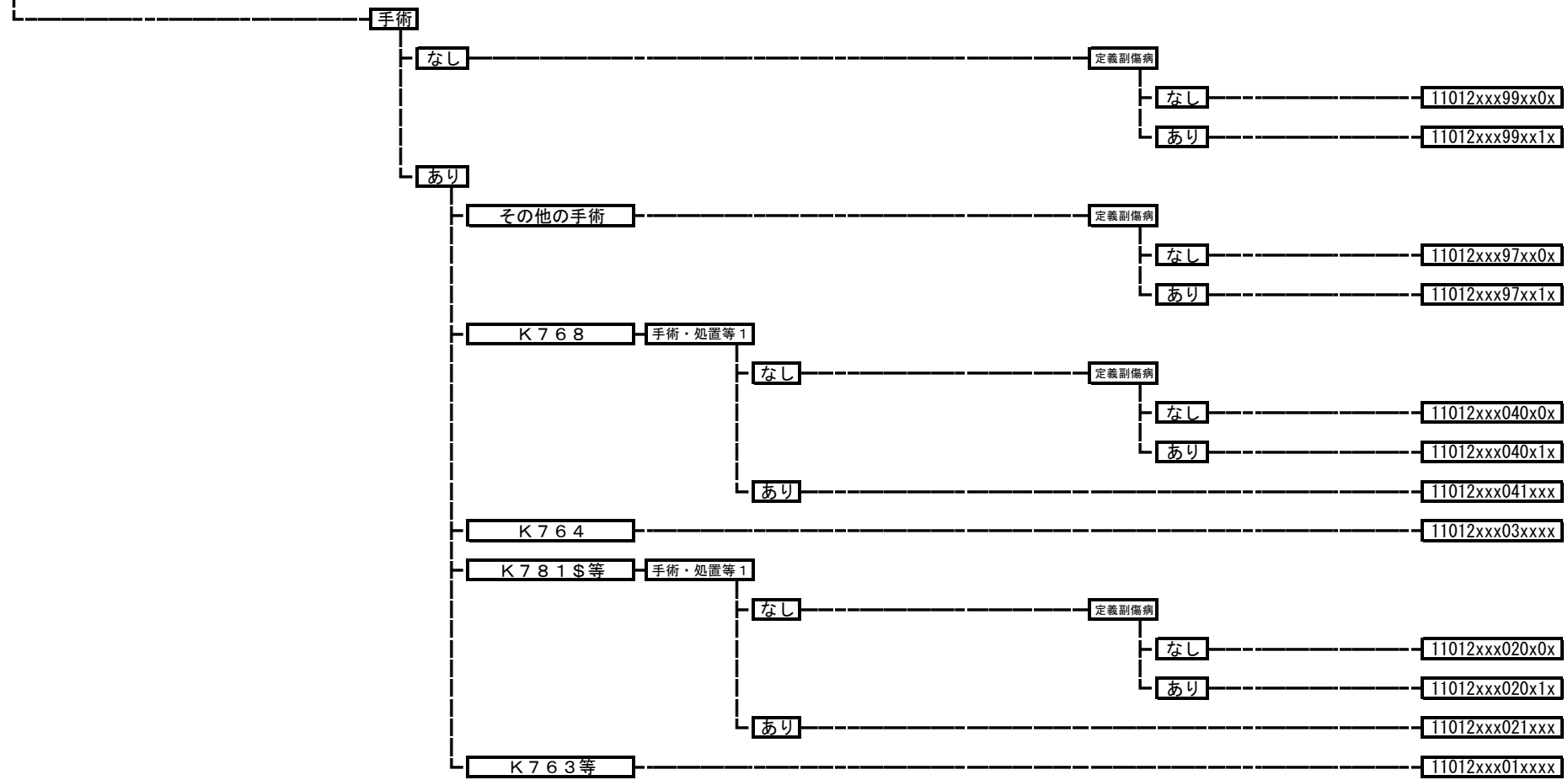

| | | |
|---------------|---------------|---------|
| 11013x | 下部尿路疾患 | |
| | 110131 | 下部尿路結石症 |
| | 110132 | 膀胱尿管逆流症 |
| | 110133 | 神経因性膀胱 |
| | 110134 | 下部尿路の炎症 |
| | 110135 | 尿道狭窄 |
| | 110136 | 尿失禁 |

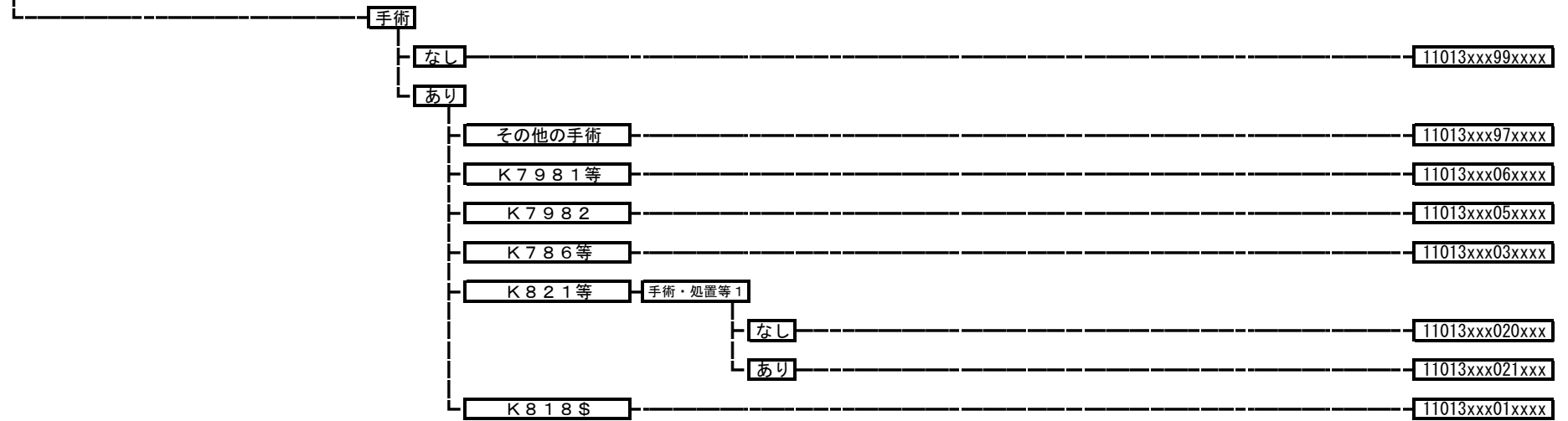

| | |
|---------------|----------------|
| 110200 | 前立腺肥大症等 |
|---------------|----------------|

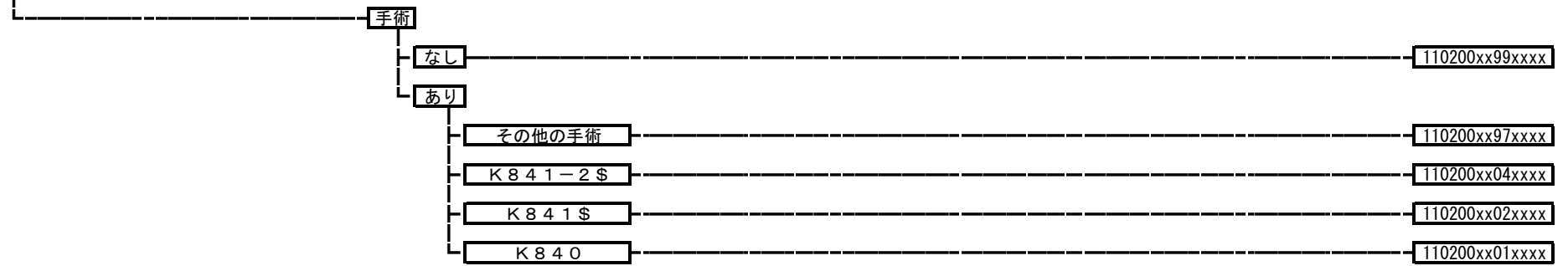

| | | |
|---------------|----------------|---------------------|
| 11022x | 男性生殖器疾患 | |
| | 110221 | 男性生殖器炎症性疾患 |
| | 110222 | 陰茎・包皮の疾患 |
| | 110223 | 陰嚢内疾患（悪性、炎症性疾患を除く。） |
| | 110224 | 男性生殖器の障害 |

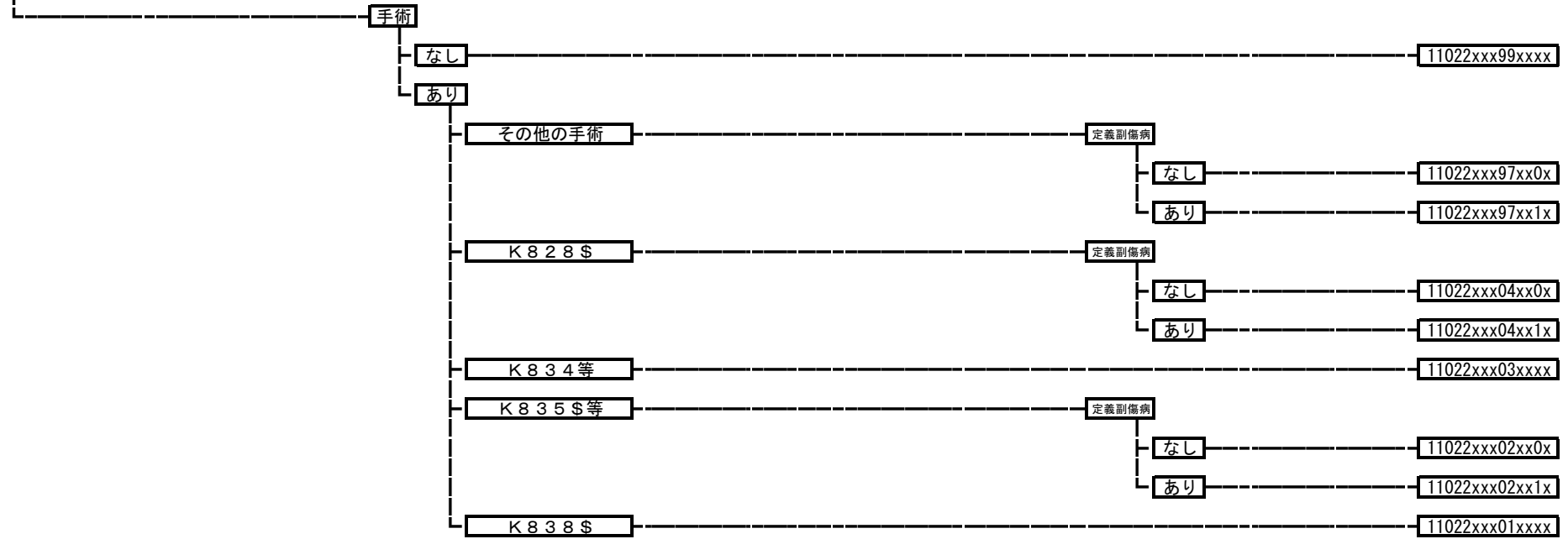

110260 ネフローゼ症候群

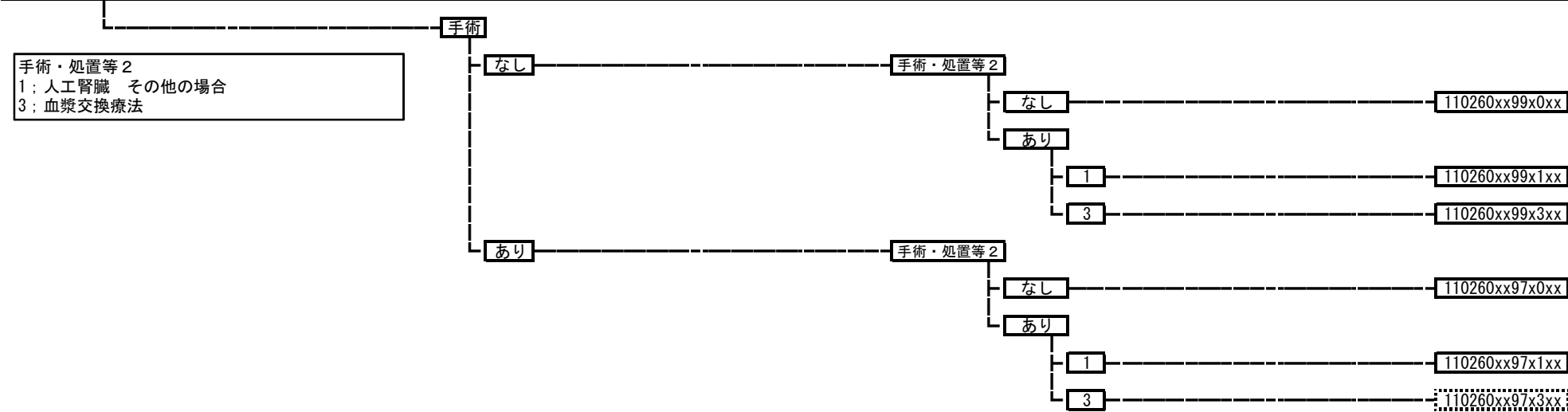

110270 急速進行性腎炎症候群

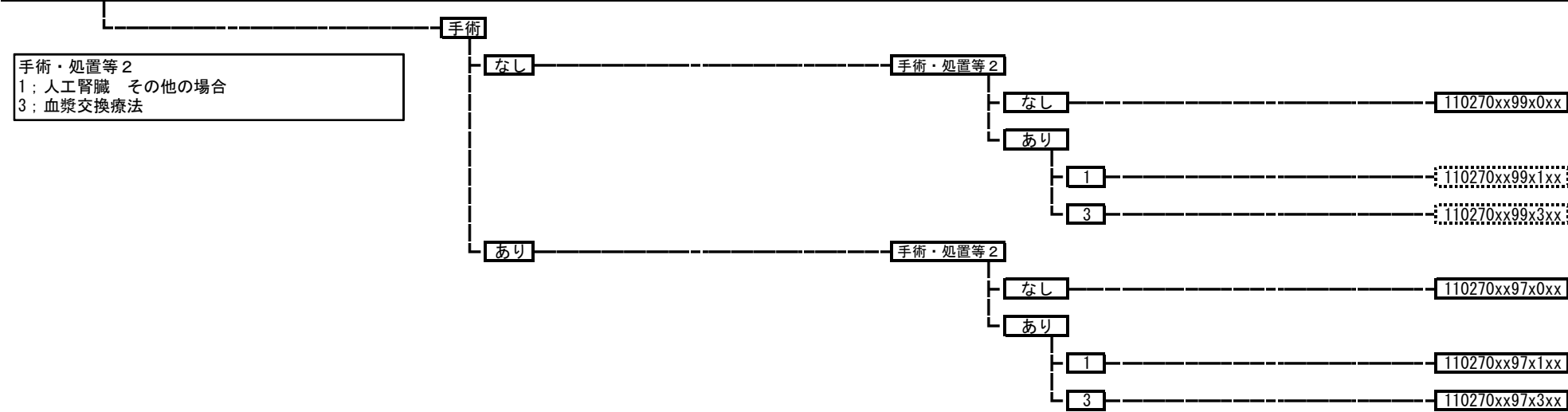

110275 急性腎炎症候群 110275xxxxxxxx

110280 慢性腎炎症候群・慢性間質性腎炎・慢性腎不全

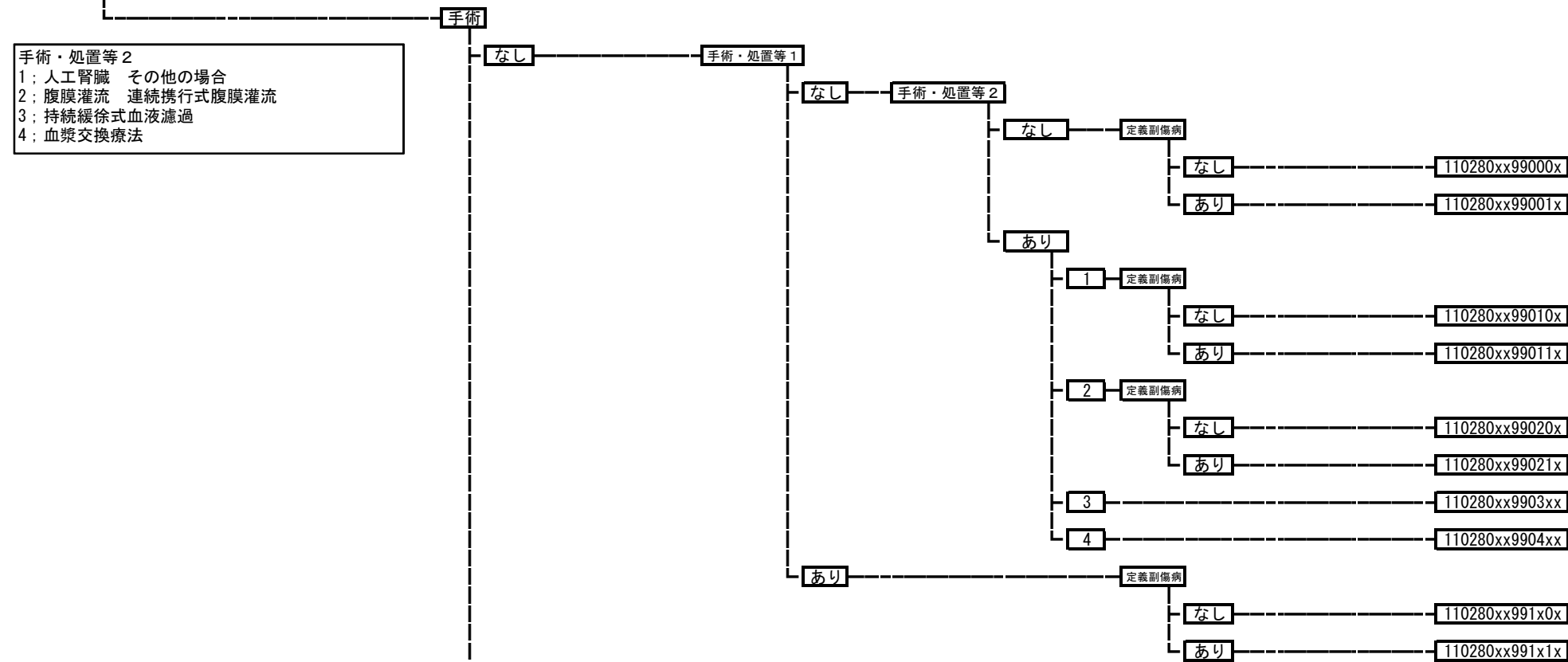

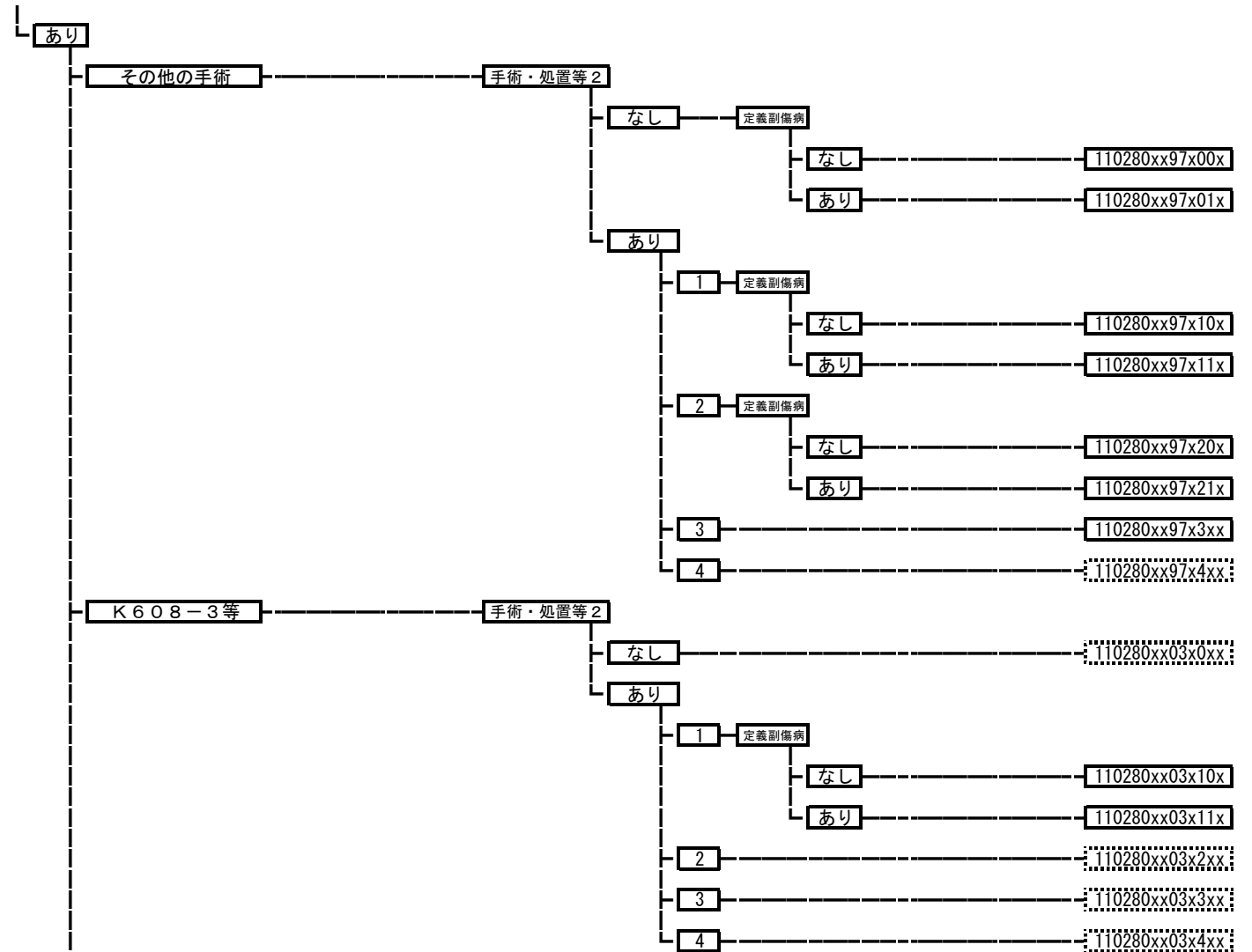

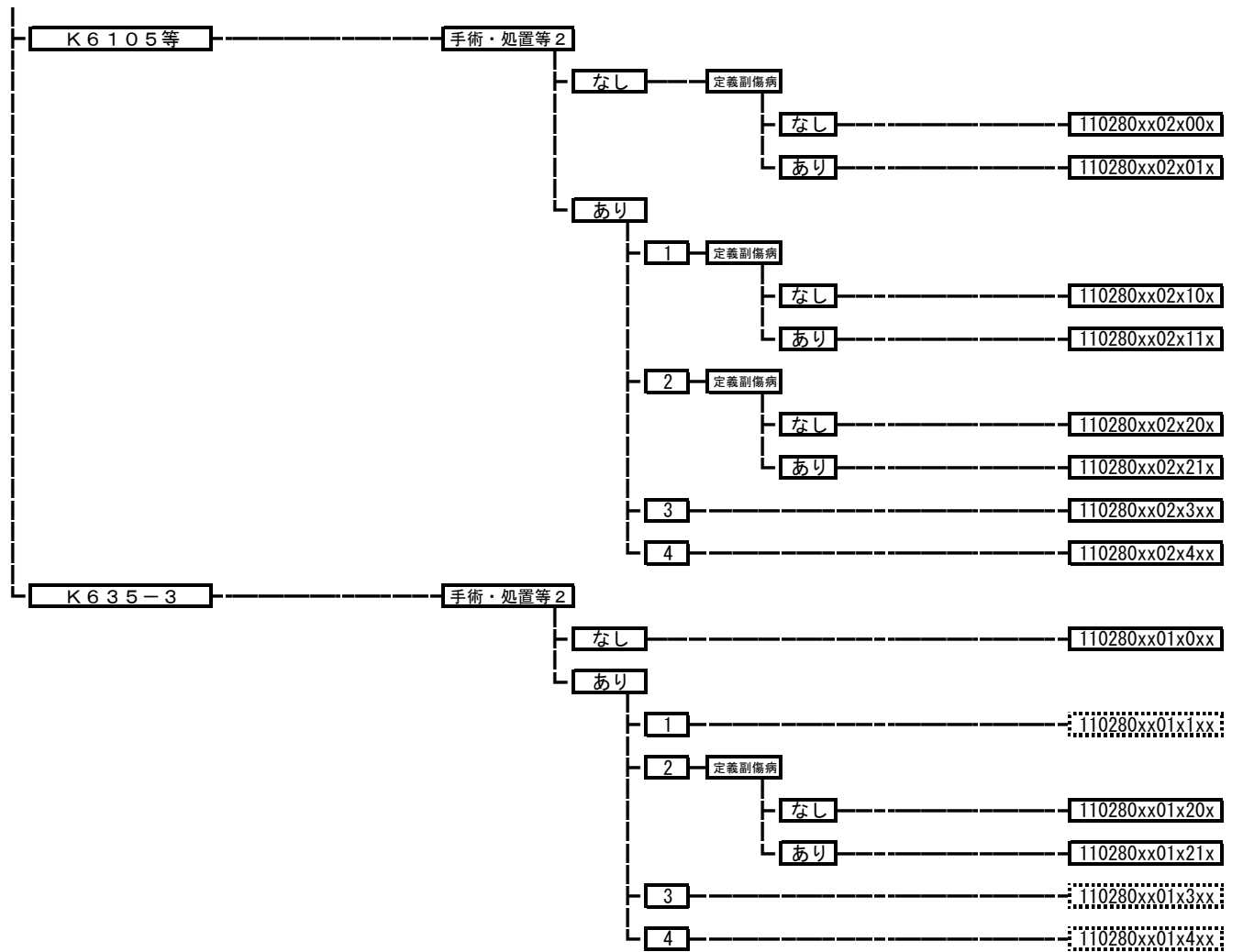

110290 急性腎不全

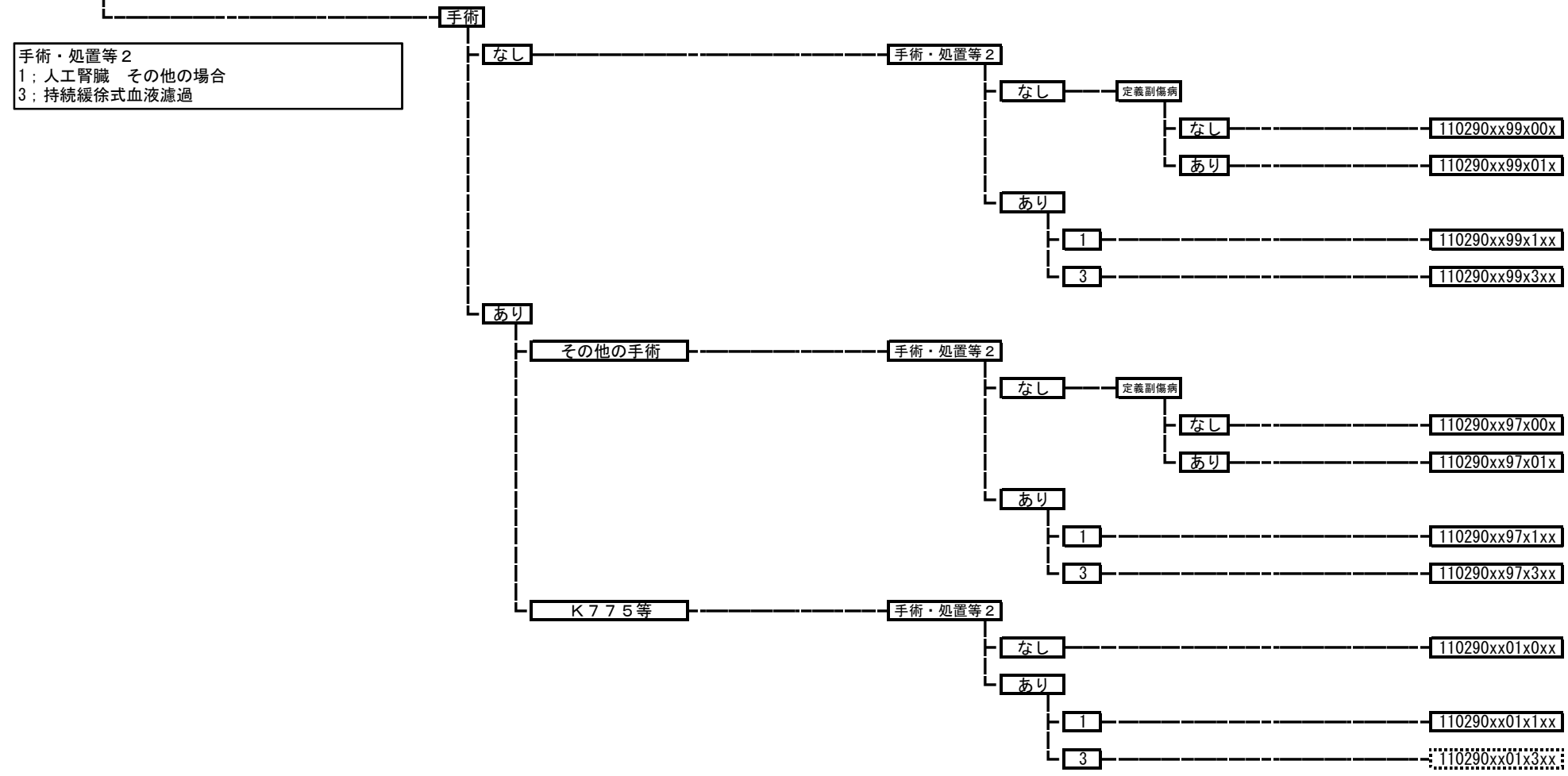

110310 腎臓または尿路の感染症

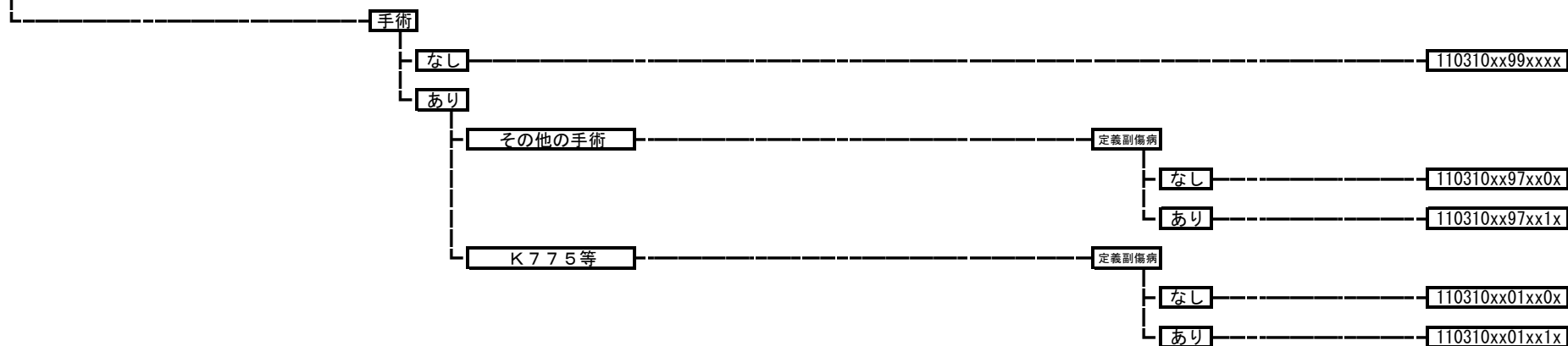

110320 腎、泌尿器の疾患（その他）

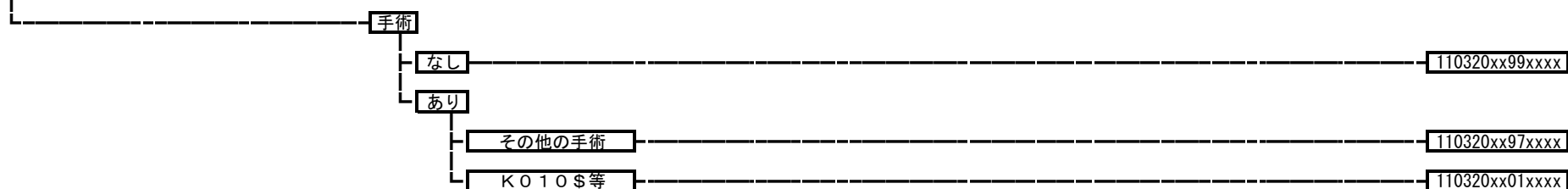

110420 水腎症（その他）

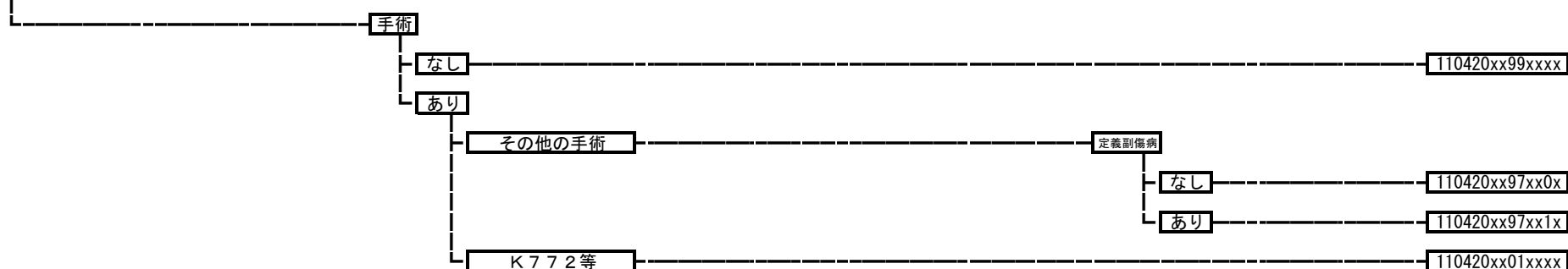

110430

腎動脈塞栓症

110430xxxxxxxx