

050010

心臓の悪性腫瘍

050010xxxxxxxx

050020 心臓の良性腫瘍

手術

なし

050020xx99xxxx

あり

その他の手術

050020xx97xxxx

K544\$

050020xx01xxxx

050030 急性心筋梗塞（続発性合併症を含む。）、再発性心筋梗塞

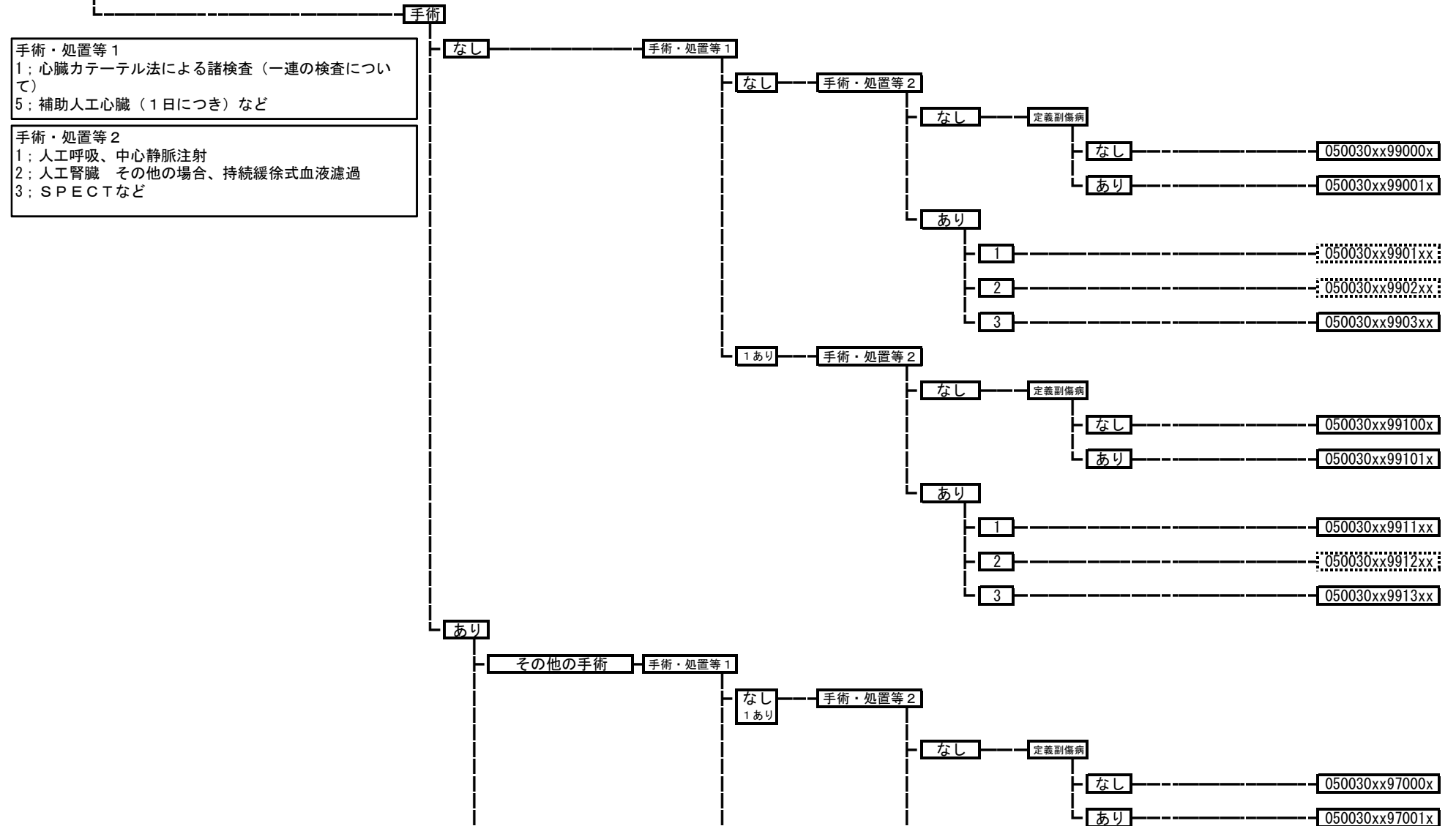

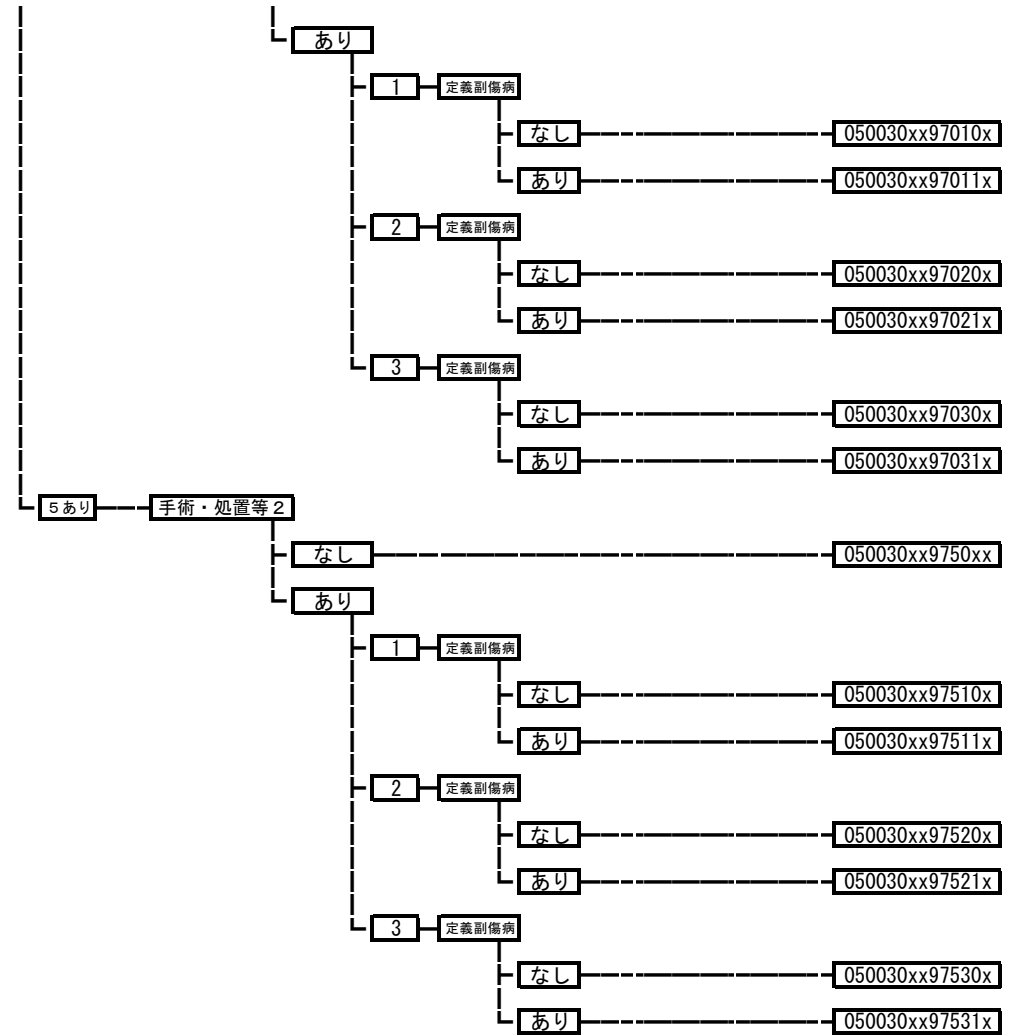

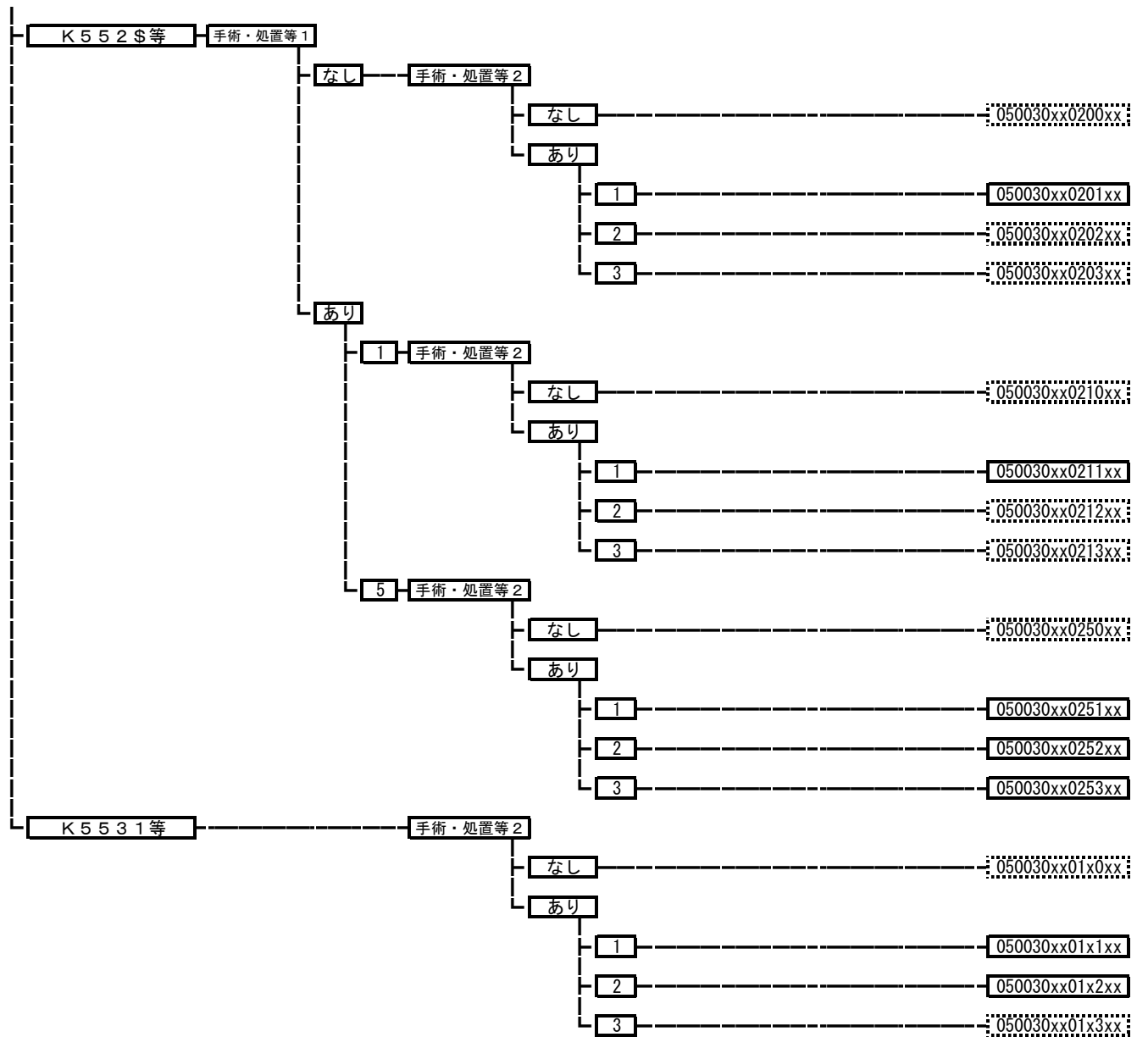

050050 狭心症、慢性虚血性心疾患

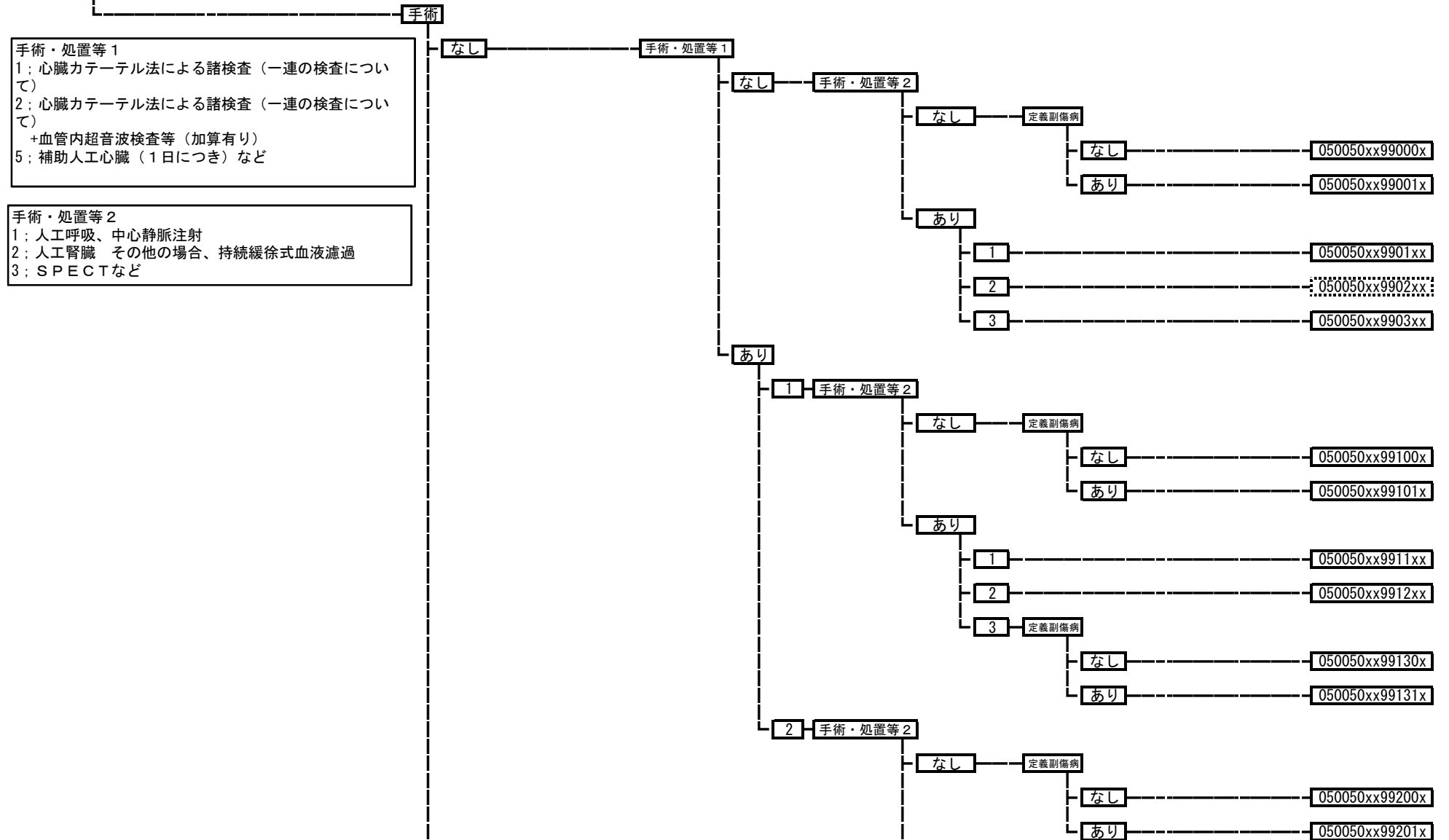

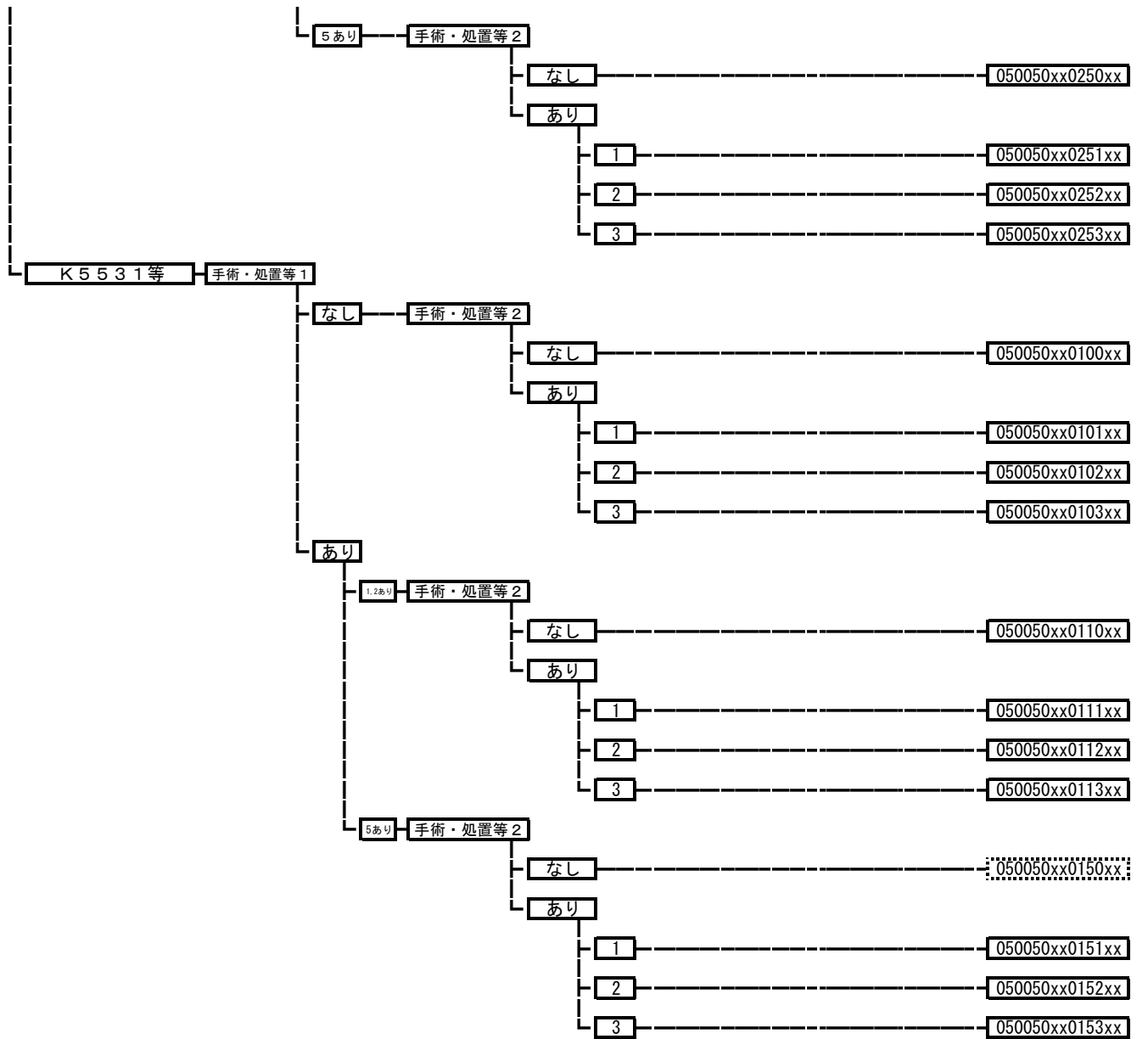

050060 心筋症（拡張型心筋症を含む。）

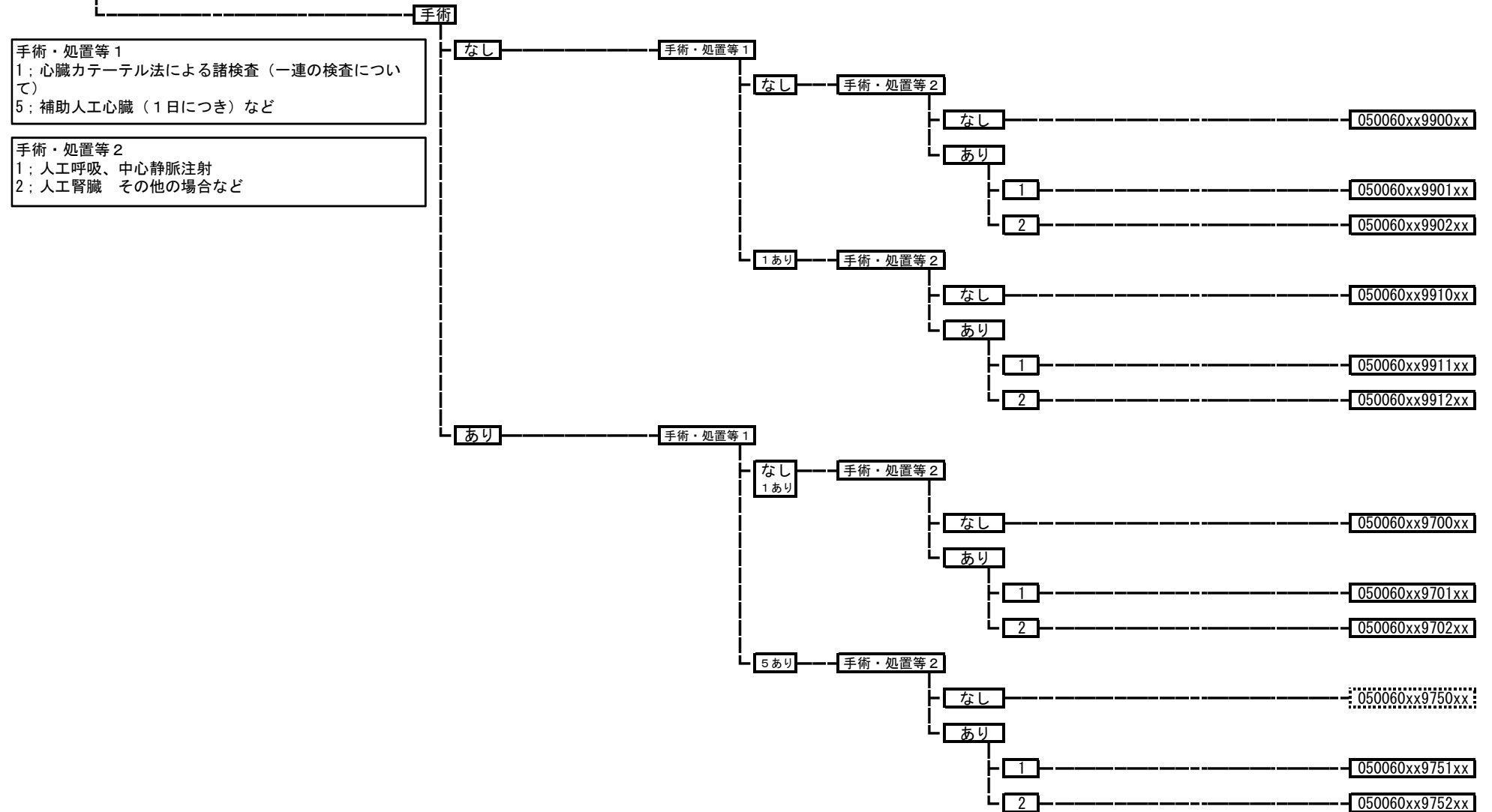

050070 頻脈性不整脈

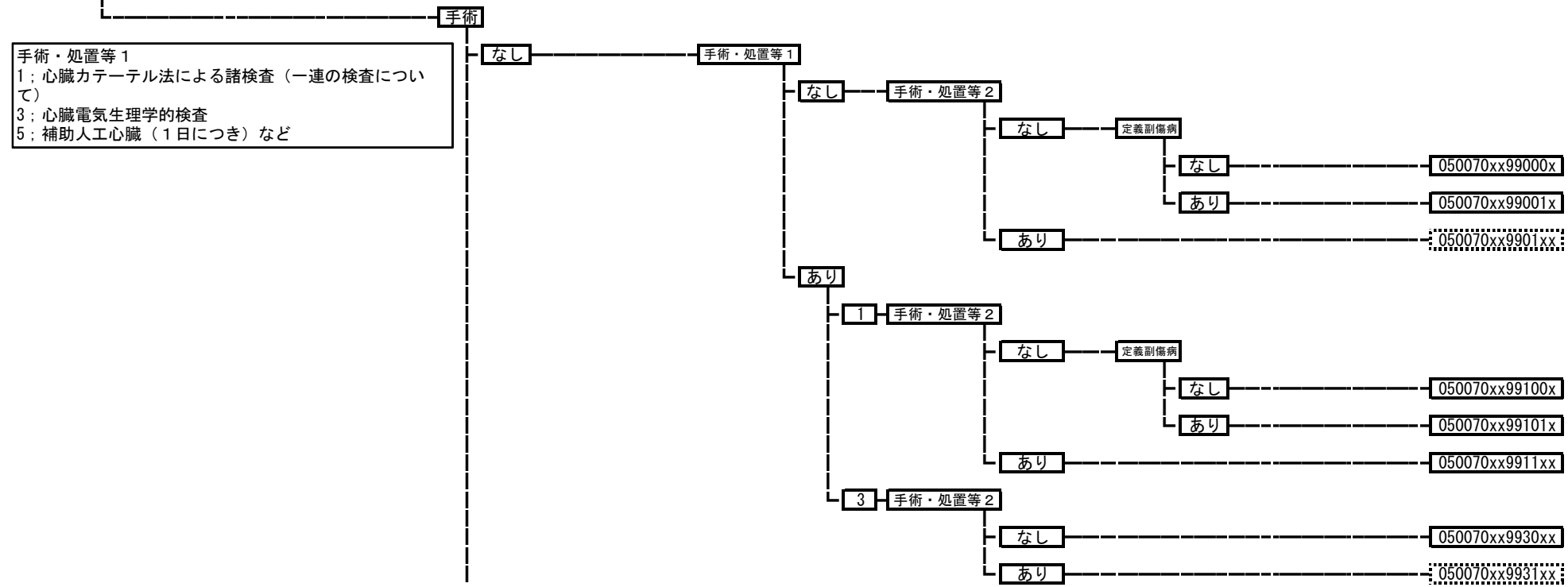

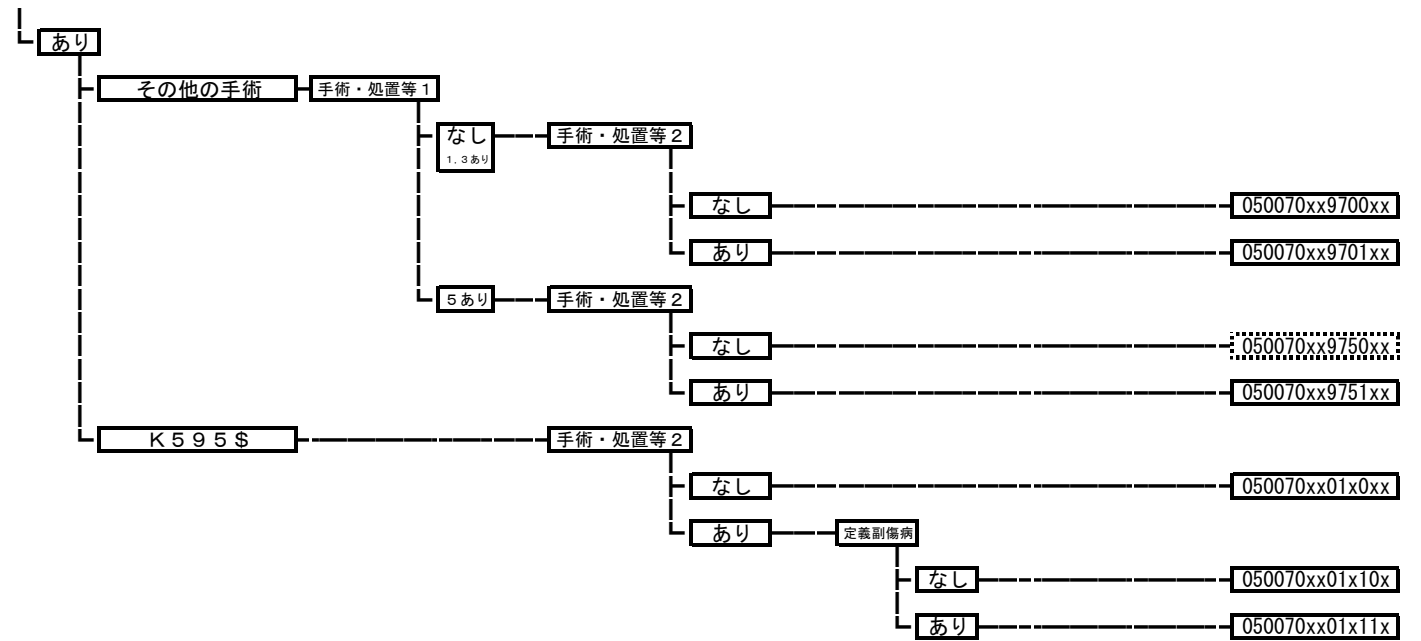

050080 弁膜症（連合弁膜症を含む。）

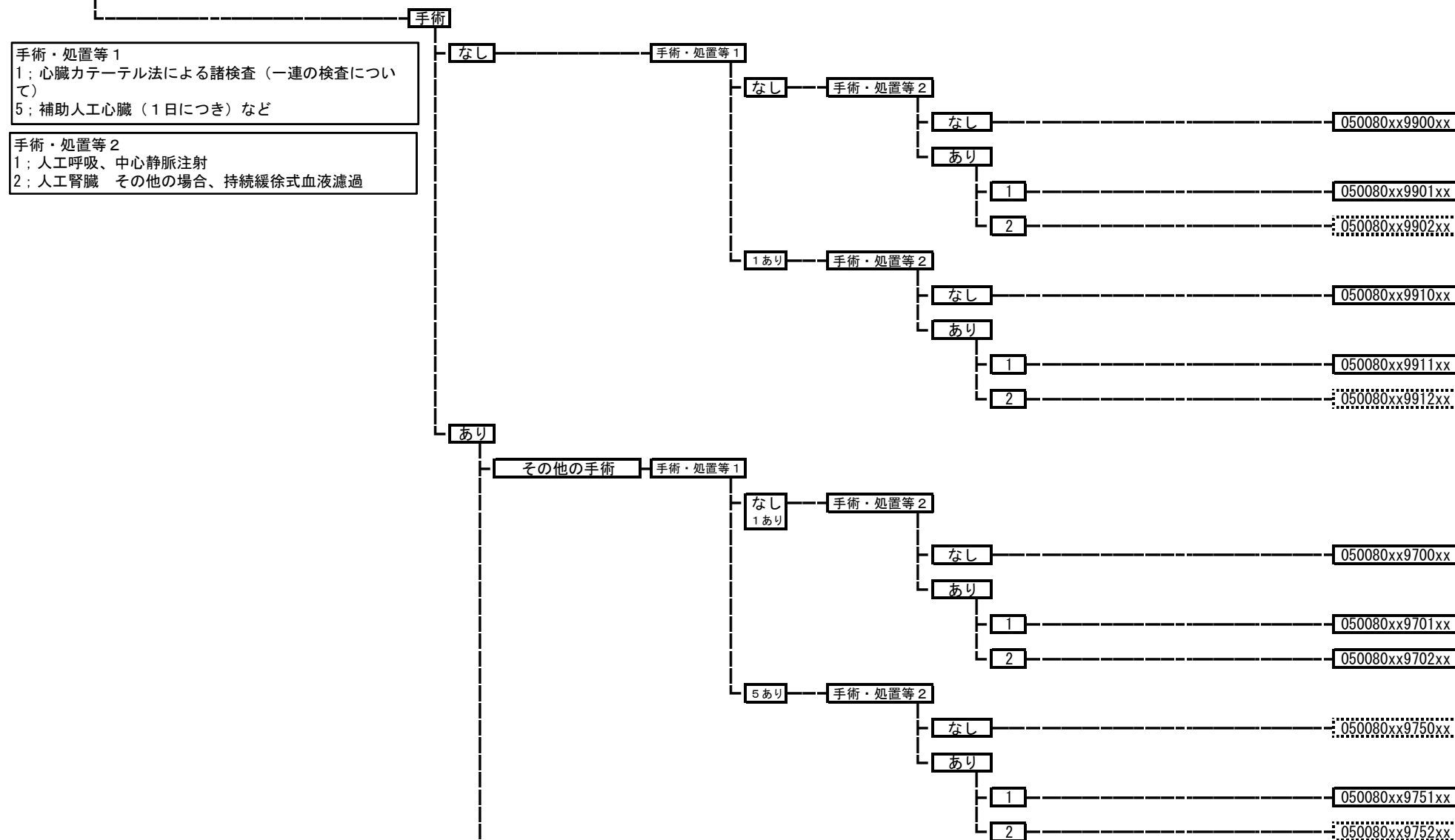

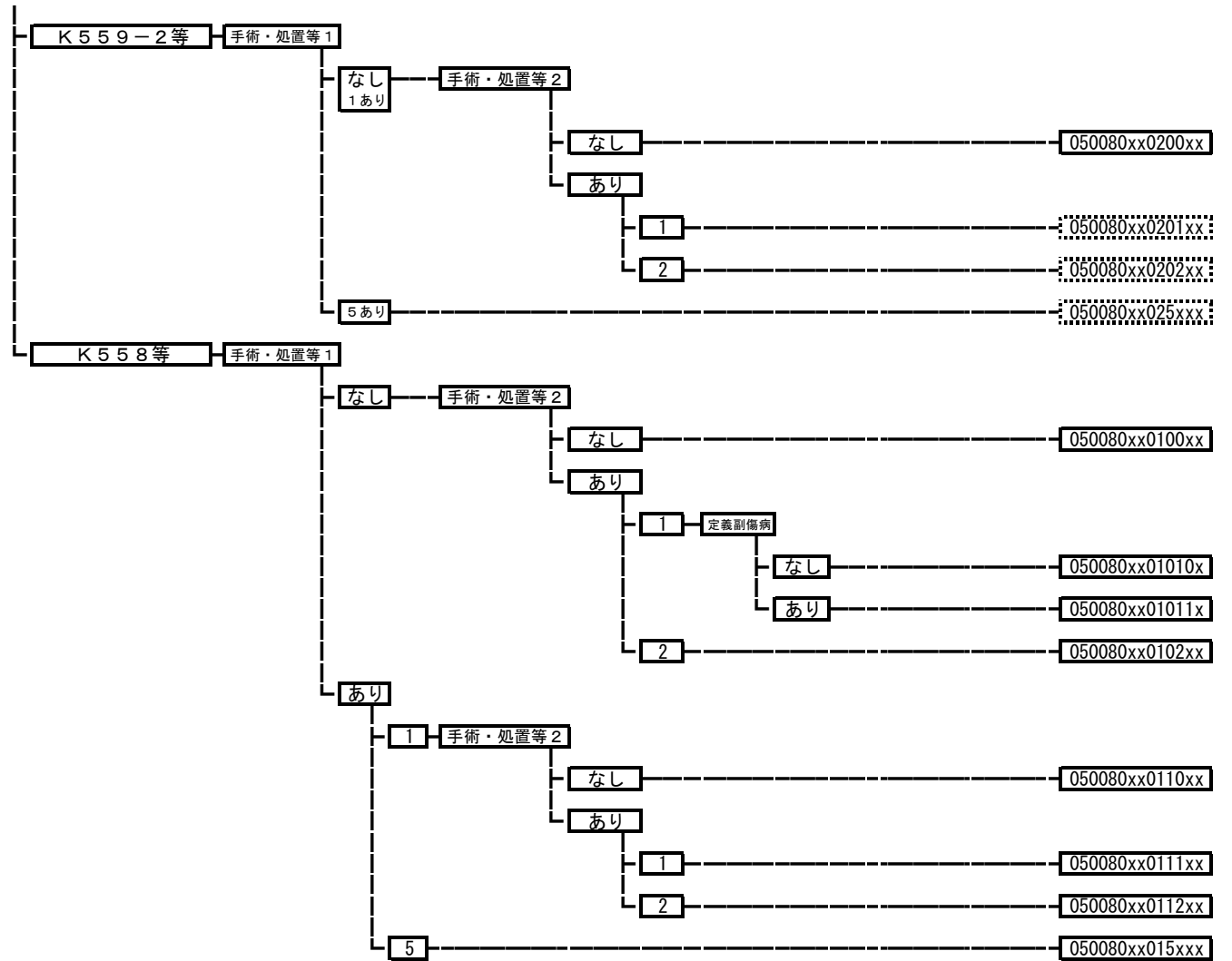

050090 心内膜炎

手術・処置等 2
 1: 人工呼吸、中心静脈注射
 2: 人工腎臓 その他の場合、持続緩徐式血液濾過

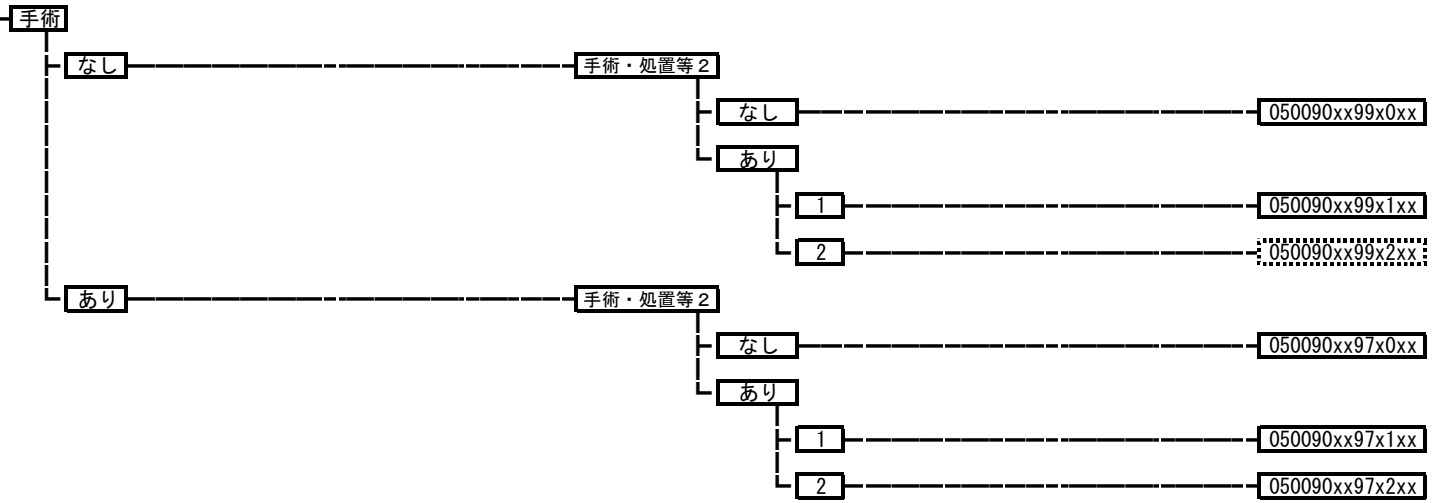

050100 心筋炎

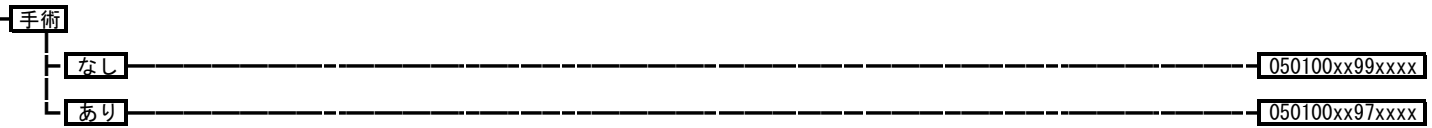

050110 急性心膜炎

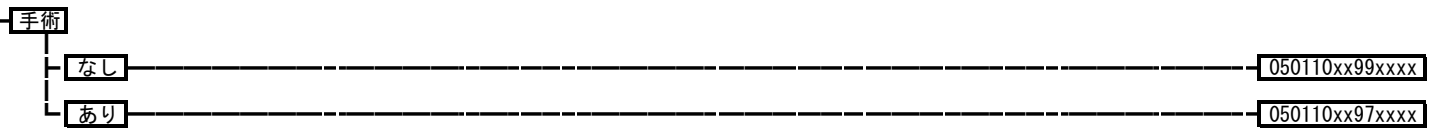

050120 収縮性心膜炎

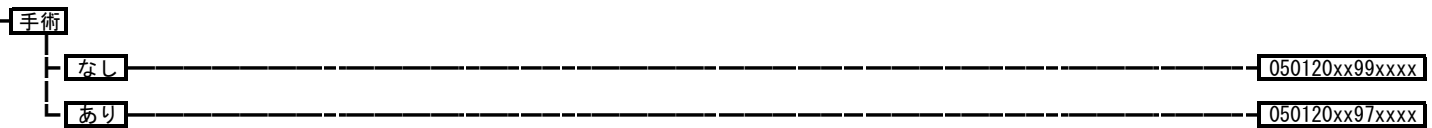

050130 心不全

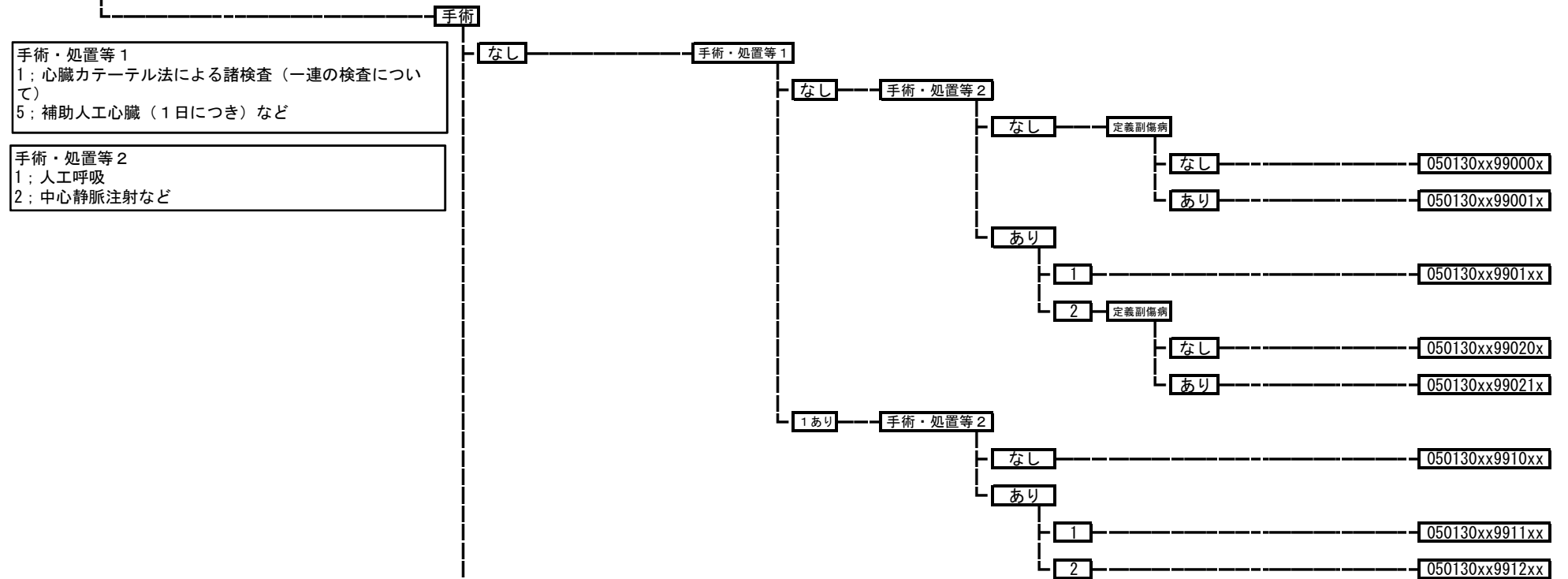

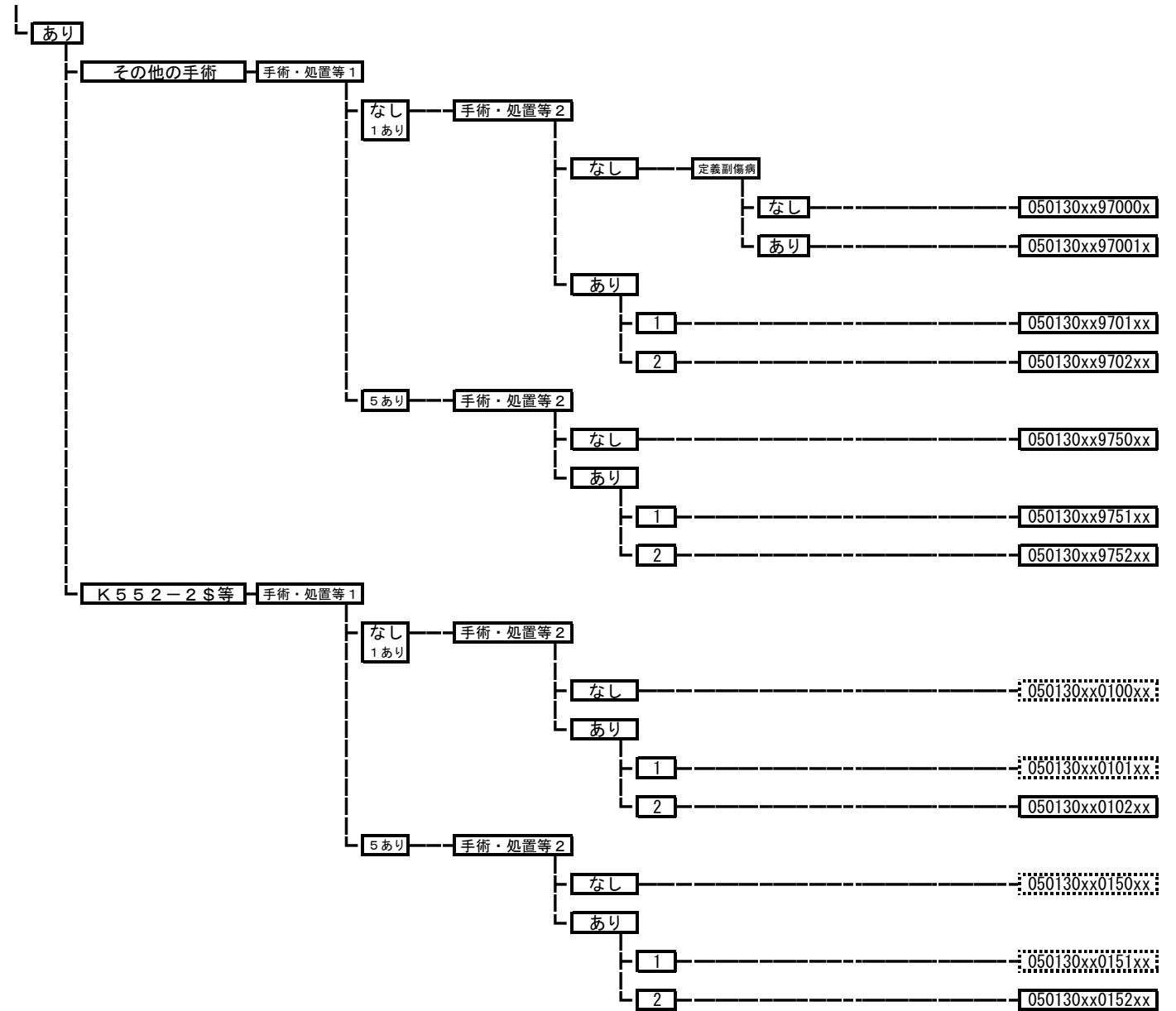

050140 高血圧性疾患

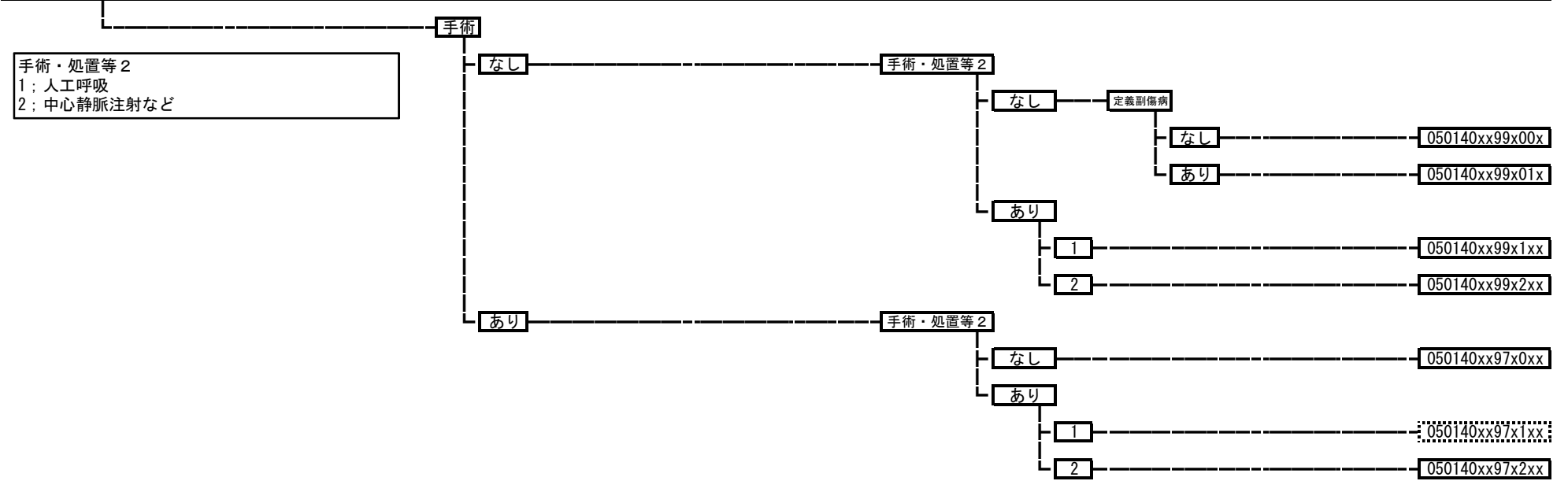

050161 解離性大動脈瘤

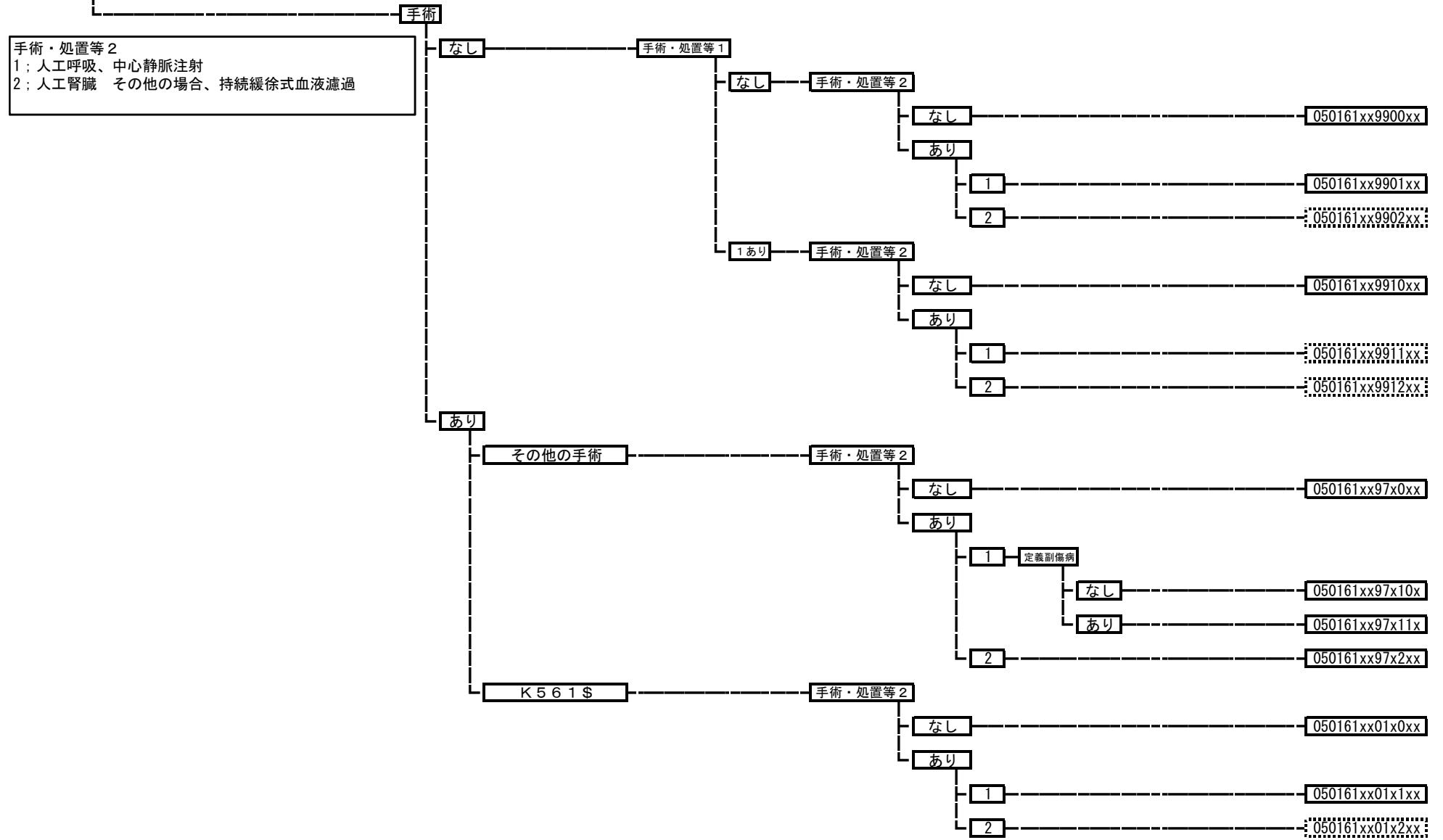

050162 破裂性大動脈瘤

手術・処置等 2
 1: 人工呼吸、中心静脈注射
 2: 人工腎臓 その他の場合、持続緩徐式血液濾過

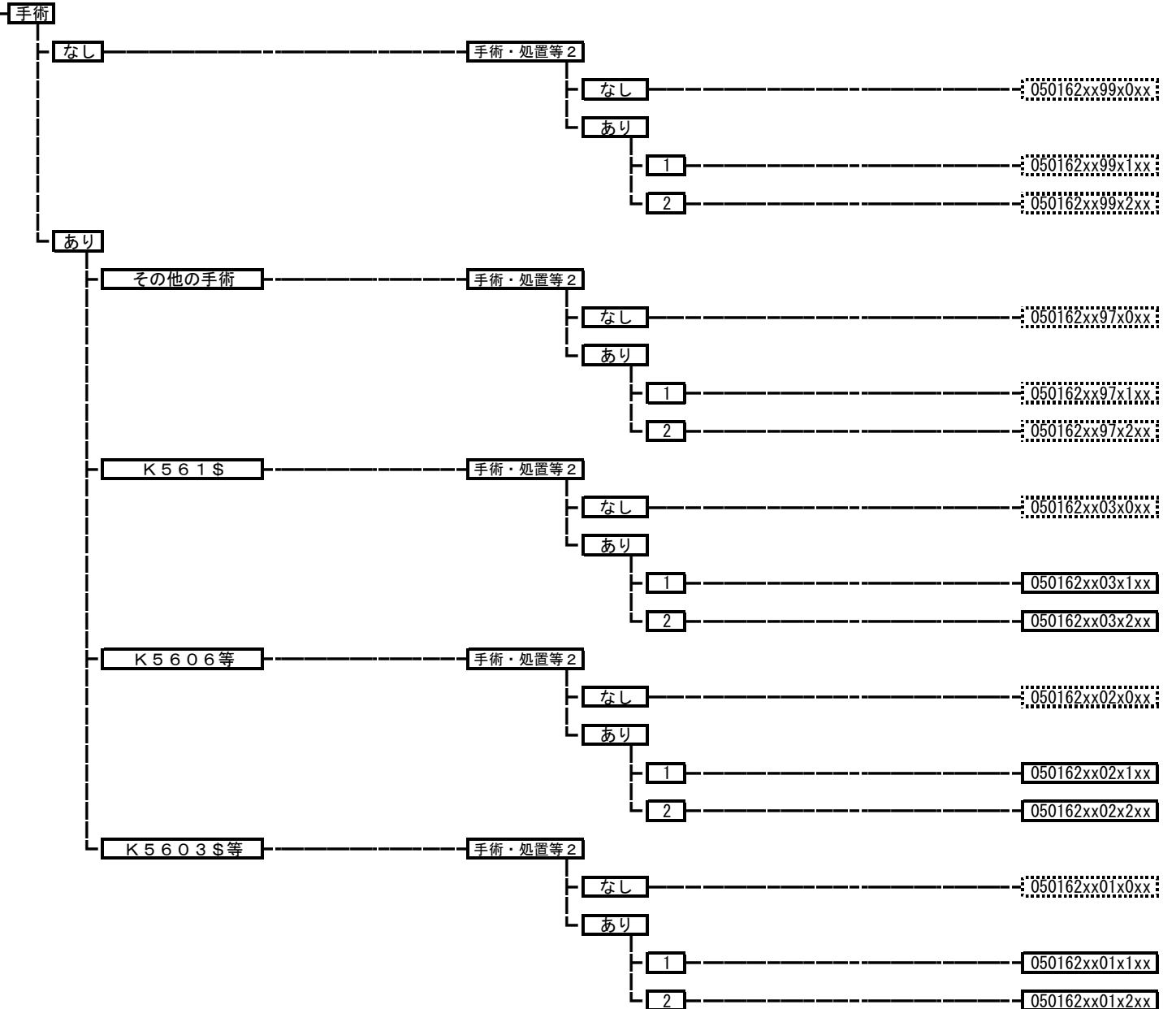

050163 非破裂性大動脈瘤、腸骨動脈瘤

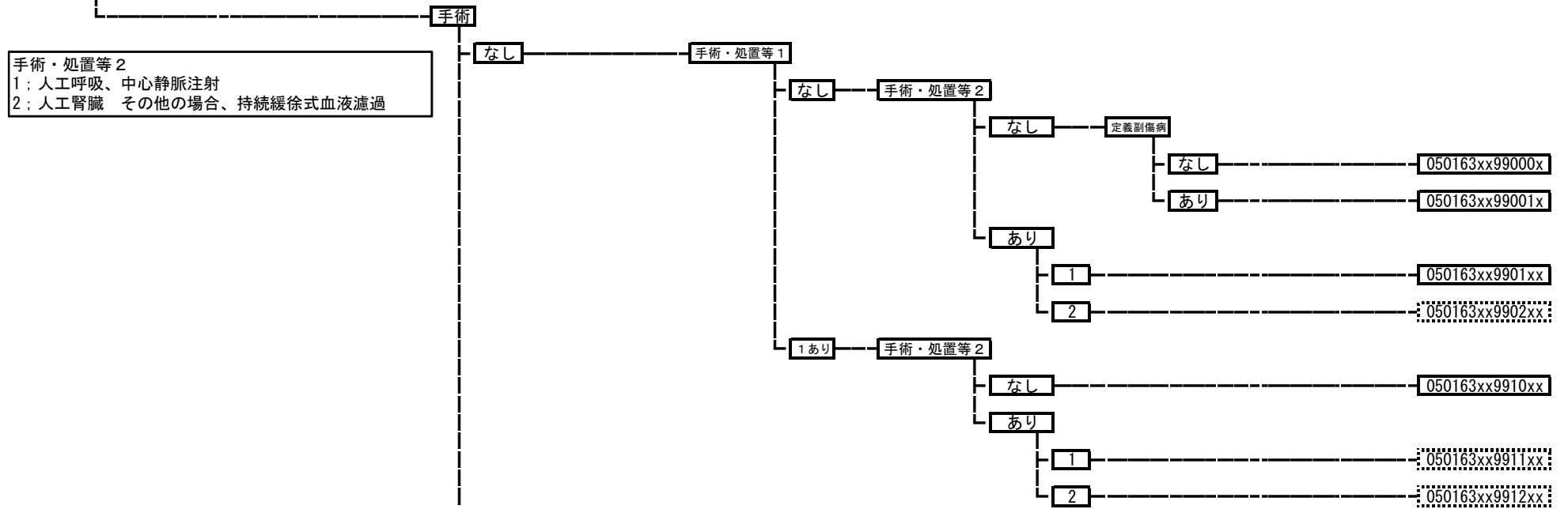

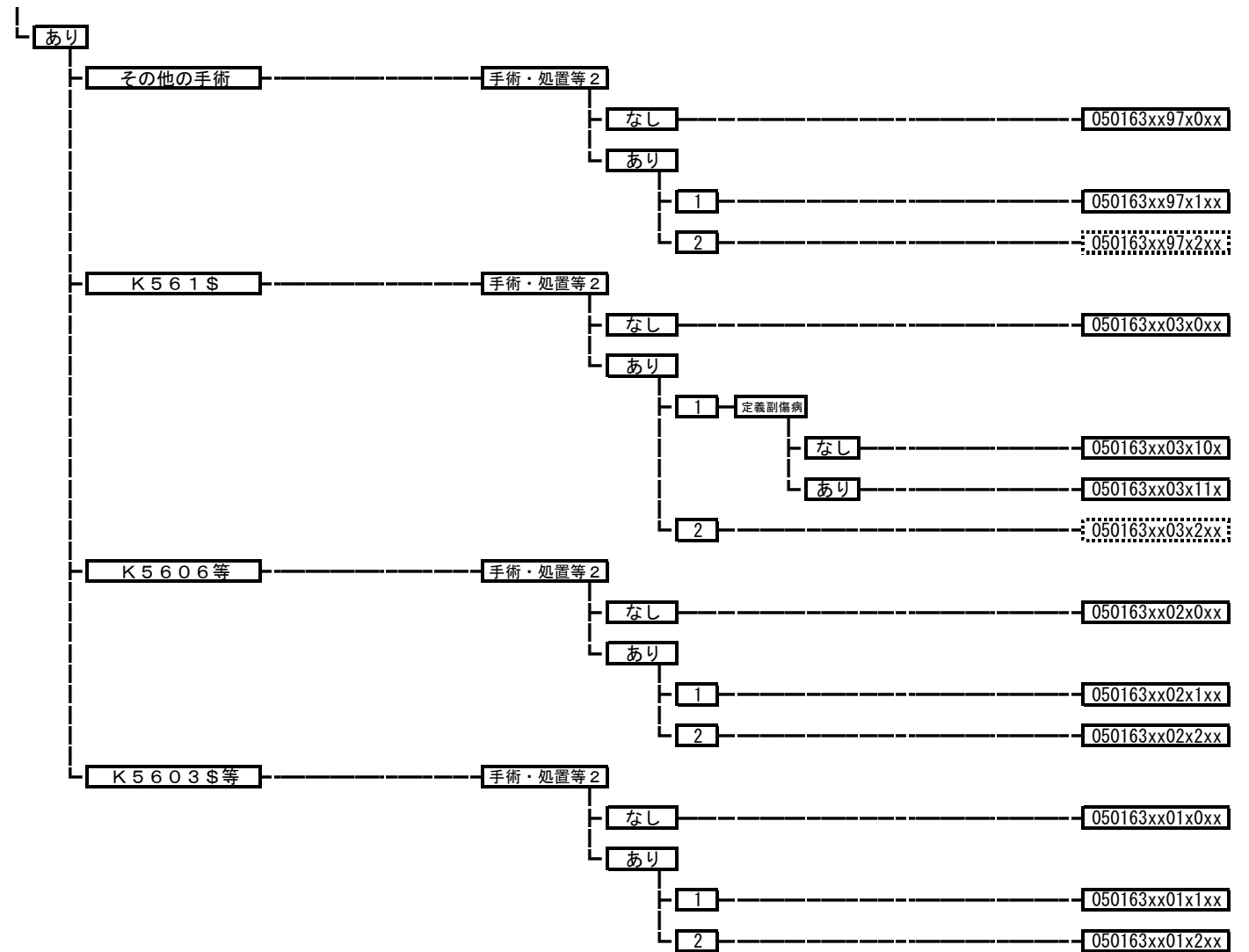

050170 閉塞性動脈疾患

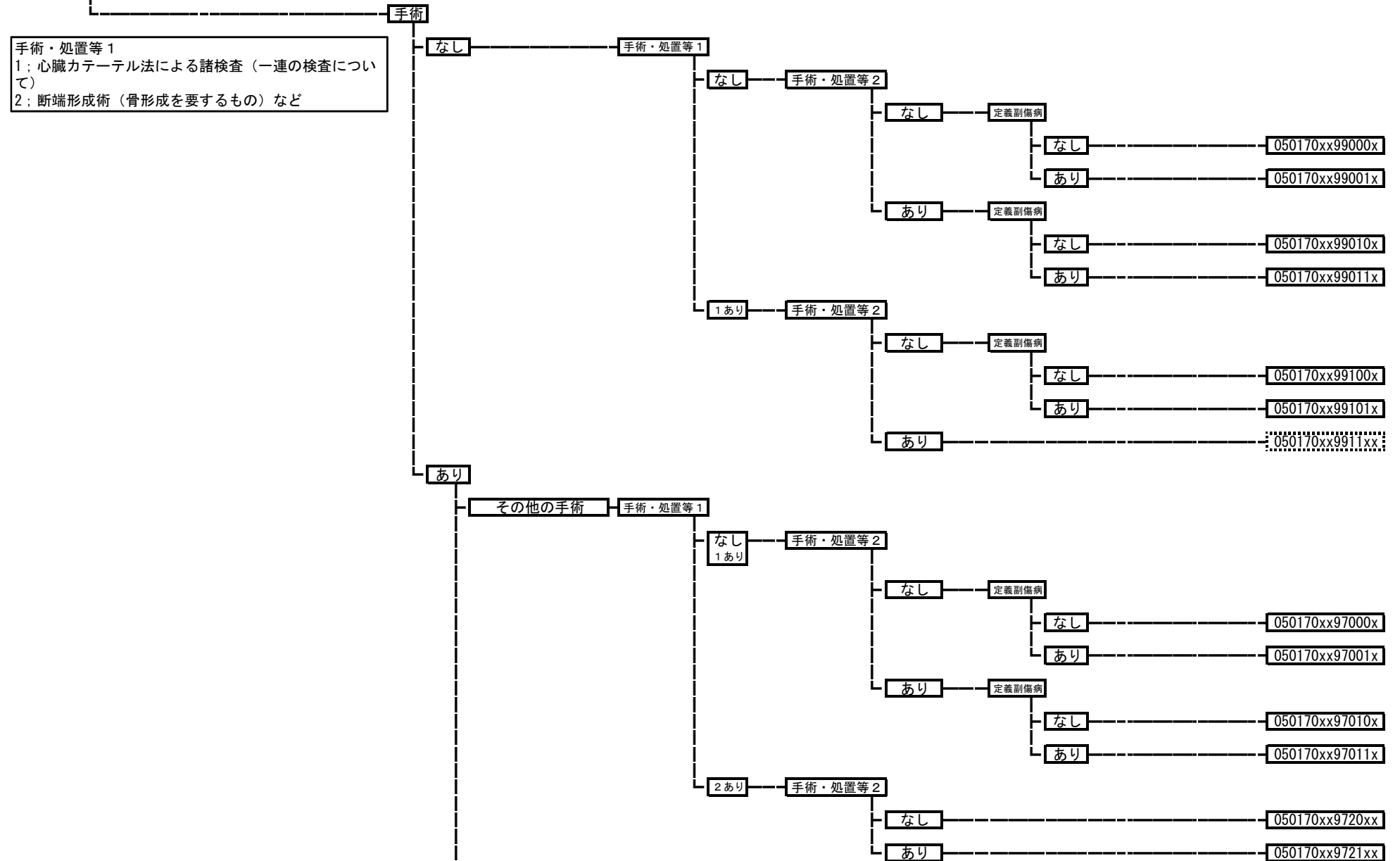

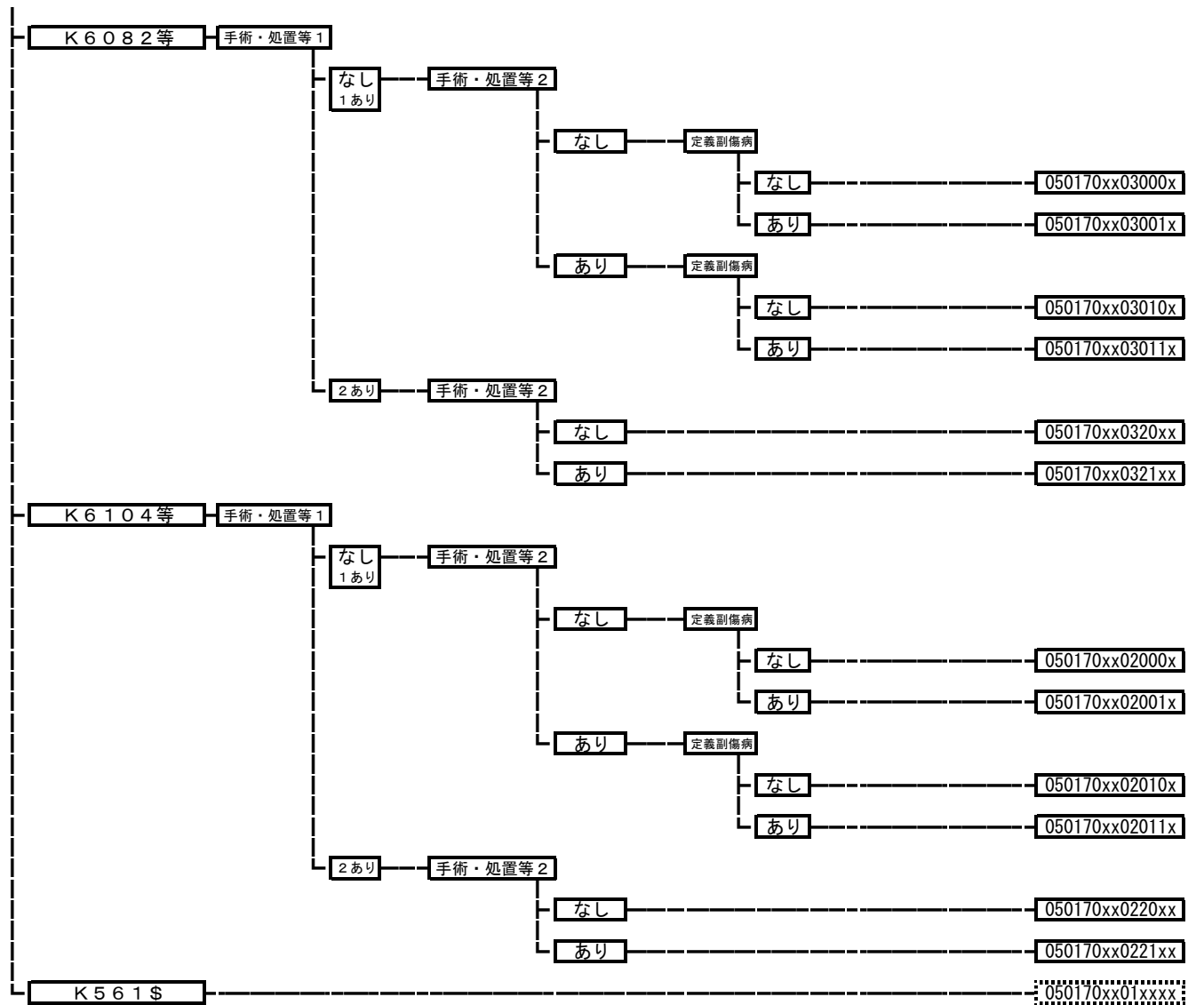

050180 静脈・リンパ管疾患

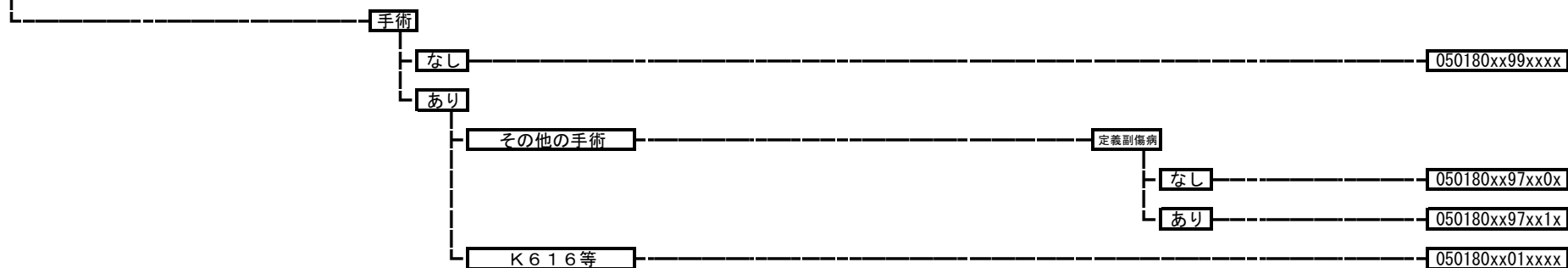

050190 肺塞栓症

手術・処置等 1
1: 心臓カテーテル法による諸検査（一連の検査について）
5: 補助人工心臓（1日につき）など

手術・処置等 2
1: 人工呼吸など
2: SPECT、シンチグラム
3: tPA

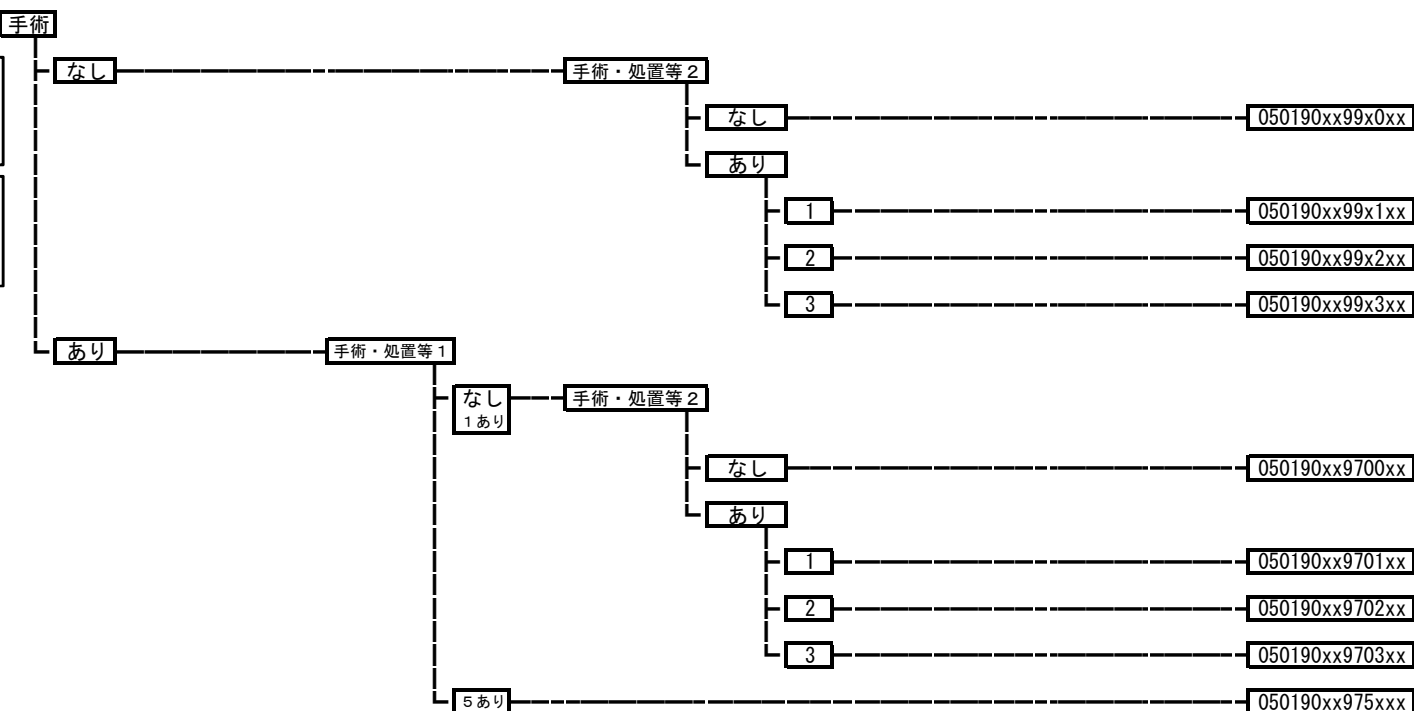

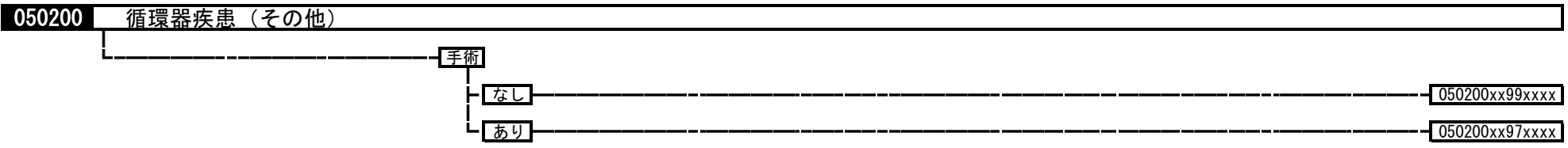

050210 徐脈性不整脈

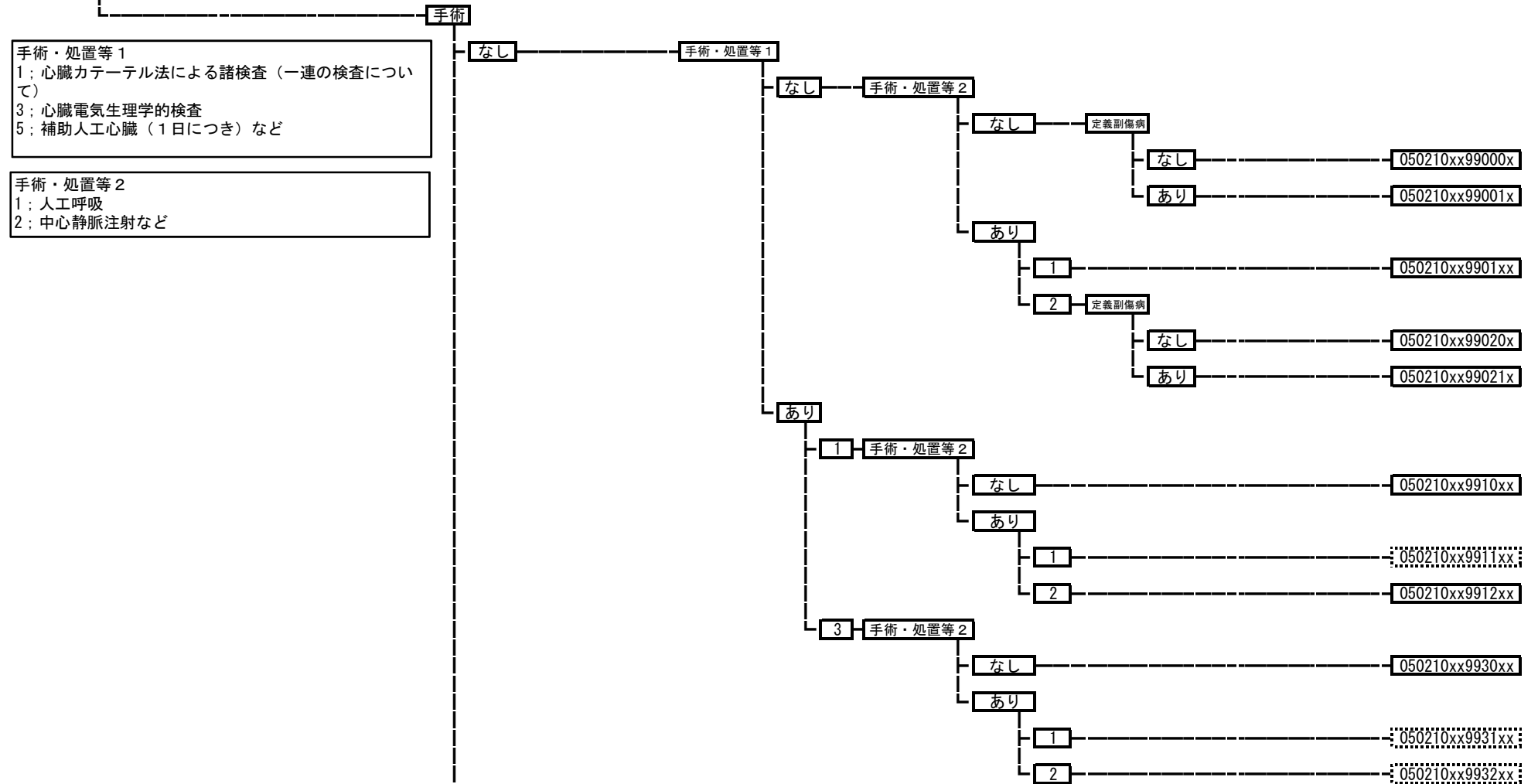

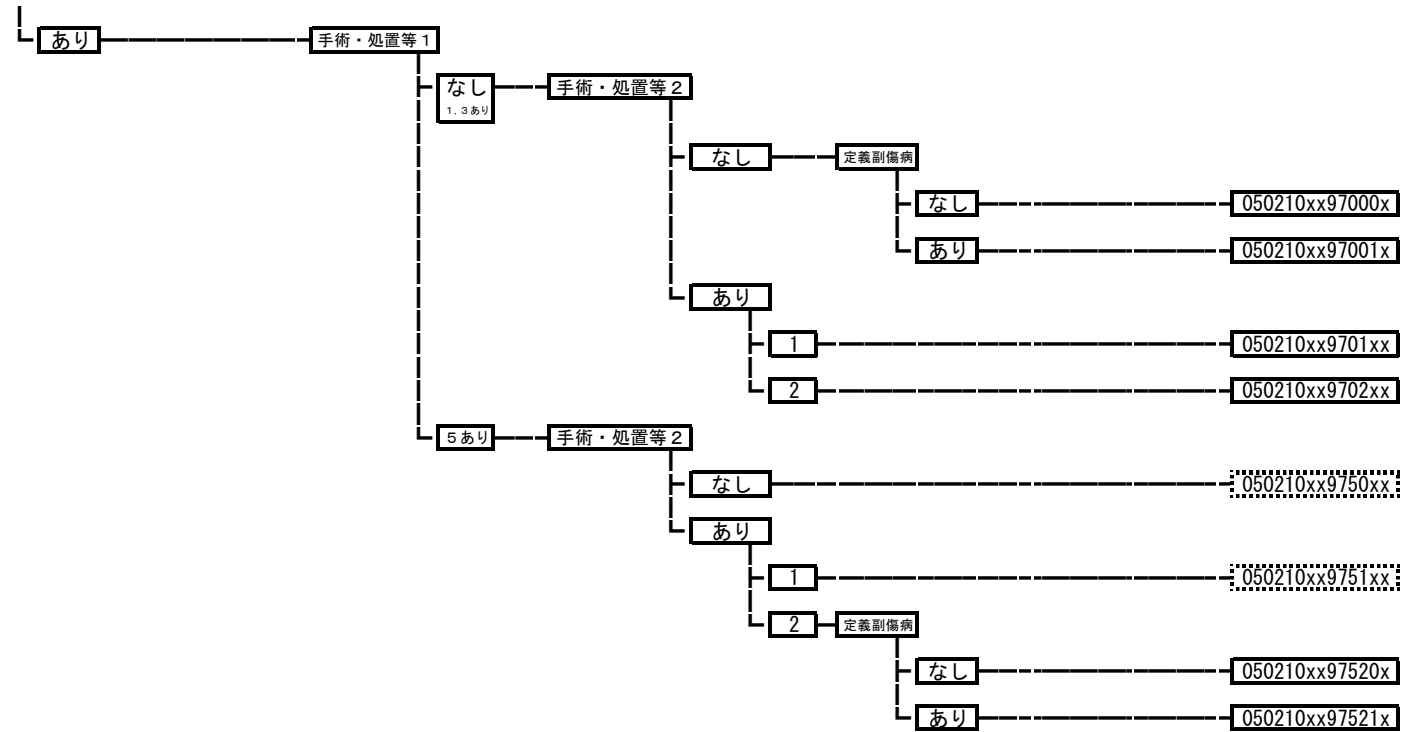

050340 その他の循環器の障害

